

MODEL NO : TM035KDGP01

MODEL VERSION: 00

SPEC VERSION : 1.0

ISSUED DATE: 2019-08-27

- Preliminary Specification
 Final Product Specification

Customer : _____

Approved by	Notes

TIANMA Confirmed :

Prepared by	Checked by	Approved by
Bei.Lei		

This technical specification is subjected to change without notice

Table of Contents

Coversheet	1
Record of Revision.....	3
1. General Specifications.....	4
2. Input/Output Terminals.....	5
3. Absolute Maximum Ratings.....	7
4. Electrical Characteristics	8
5. Timing Chart.....	10
6. Optical Characteristics	16
7. Environmental / Reliability Tests	20
8. Mechanical Drawing.....	21
9. Packing Drawing	22
10. Precautions For Use of LCD modules	22

TIANMA CONFIDENTIAL

1. General Specifications

	Feature	Spec
Display Spec.	Size	3.5inch
	Resolution	320(RGB) X 240
	Technology Type	a-Si
	Pixel Configuration	R.G.B. Vertical Stripe
	Pixel pitch(mm)	0.219 x 0.219
	Display Mode	Normally Black
	Surface Treatment	HC
	Viewing Direction	All
	Gray Scale Inversion Direction	N/A
Mechanical Characteristics	LCM (W x H x D) (mm)	76.9x63.9x3.15
	Active Area(mm)	70.08 x 52.56
	With /Without TSP	Without TSP
	Connection Type	Kyocera elco:6240 serials
	LED Numbers	6 LEDs
	Weight (g)	TBD
Electrical Characteristics	Interface	RGB 24bit+SPI or RGB24bit
	Color Depth	16.7M
	Driver IC	ST7272A

Note 1: Viewing direction for best image quality is different from TFT definition, there is a 180 degree shift.

Note 2: Requirements on Environmental Protection: ROHS

Note 3: LCM weight tolerance: $\pm 5\%$

2 Input/Output Terminals

2.1 TFT LCD Panel

Recommend connector: Kyocera elco:6240 serials

No	Symbol	I/O/P	Description	Remarks
1	LED_Cathode	P	LED_Cathode	
2	LED_Cathode	P	LED_Cathode	
3	LED_Anode	P	LED_Anode	
4	LED_Anode	P	LED_Anode	
5	NC	-	No Connect	
6	NC	-	No Connect	
7	NC	-	No Connect	
8	RESET	I	Reset	
9	SPENA	I	Serial port data enable signal	
10	SPCK	I	SPI Serial Clock	
11	SPDA	I/O	SPI Serial Data Input	
12	D00	I	Data 00	
13	D01	I	Data 01	
14	D02	I	Data 02	
15	D03	I	Data 03	
16	D04	I	Data 04	
17	D05	I	Data 05	
18	D06	I	Data 06	
19	D07	I	Data 07	
20	D08	I	Data 08	
21	D09	I	Data 09	
22	D10	I	Data 10	
23	D11	I	Data 11	
24	D12	I	Data 12	
25	D13	I	Data 13	
26	D14	I	Data 14	
27	D15	I	Data 15	

The information contained herein is the exclusive property of SHANGHAI TIANMA MICRO-ELECTRONICS Corporation, and shall not be distributed, reproduced, or disclosed in whole or in part without prior written permission of SHANGHAI TIANMA MICRO-ELECTRONICS Corporation.

28	D16	I	Data 16	
29	D17	I	Data 17	
30	D18	I	Data 18	
31	D19	I	Data 19	
32	D20	I	Data 20	
33	D21	I	Data 21	
34	D22	I	Data 22	
35	D23	I	Data 23	
36	HSYNC	I	Horizontal Synchronous Signal	
37	VSYNC	I	Vertical Synchronous Signal	
38	DOTCLK	I	Data Clock	
39	NC	-	No Connect	
40	NC	-	No Connect	
41	VDD	P	power supply (3.3V)	
42	VDD	P	power supply (3.3V)	
43	NC	-	No Connect	
44	NC	-	No Connect	
45	NC	-	No Connect	
46	NC	-	No Connect	
47	NC(AUTODL)	-	No Connect (Auto-refresh function control pin.)	
48	NC(DISP)	-	No Connect (Sets the display mode.)	
49	NC(ENPROG)	-	No Connect (OTP program control pin.)	
50	NC	-	No Connect	
51	NC	-	No Connect	
52	DEN	I	Data enabling signal	
53	GND	P	Ground	
54	GND	P	Ground	

Note2-1: I/O definition:

I----Input O----Output I/O----Input/Output P----Power/Ground

3 Absolute Maximum Ratings

3.1 Driving TFT LCD Panel

GND=0V

Item	Symbol	Min	Max	Unit	Remark
Power Supply Voltage	VDD	-0.3	4.0	V	
Logic Input Signal Voltage	R7~R2,G7~G2, B7~B2,RESET SPENA,SPCK SPDA,HSYNC	-0.3	VDD+0.3	V	
Back Light Forward Current	I _{LED}	--	20	mA	For each LED
Operating Temperature	T _{OPR}	-20	70	°C	
Storage Temperature	T _{STG}	-30	80	°C	
Relative Humidity (Note1)	RH	--	≤95	%	Ta≤40°C
		--	≤85	%	40°C<Ta≤50°C
		--	≤55	%	50°C<Ta≤60°C
		--	≤36	%	60°C<Ta≤70°C
		--	≤24	%	70°C<Ta≤80°C
Absolute Humidity	AH	--	≤70	g/m ³	Ta>70°C

Note1: Ta means the ambient temperature.

It is necessary to limit the relative humidity to the specified temperature range.
Condensation on the module is not allowed.

4 Electrical Characteristics

4.1 Driving TFT LCD Panel

GND=0V, Ta=25°C

Item		Symbol	Min	Typ	Max	Unit	Remark
Power Supply Voltage		VDD	3.2	3.3	3.4	V	
Input Signal Voltage	Low Level	VIL	GND	--	0.3*VDD	V	
	High Level	VIH	0.7*VDD	--	VDD	V	
(Panel+ LSI) Power Consumption		Black Mode (60Hz)	--	TBD	--	mW	
		Standby Mode	--	TBD	--	mW	

4.2 Driving Backlight

Ta=25°C

Item	Symbol	Min	Typ	Max	Unit	Remark
Forward Current	I _F	--	20	--	mA	
Forward Voltage	V _F	--	18	--	V	
Power Consumption	W _{BL}		TBD		mW	
Operating Life Time	--	10000	20000	--	Hrs	

Note 1: The figure below shows the connection of backlight LED.



Note 2: Each LED : I=20 mA, V =3V

Note 3: IF is defined for one channel LED.

Optical performance should be evaluated at Ta=25°C only.

If LED is driven by high current, high ambient temperature & humidity condition, the life time of LED will be reduced.

Operating life means brightness goes down to 50% initial brightness. Typical operating life time is estimated data.

4.3 Block Diagram

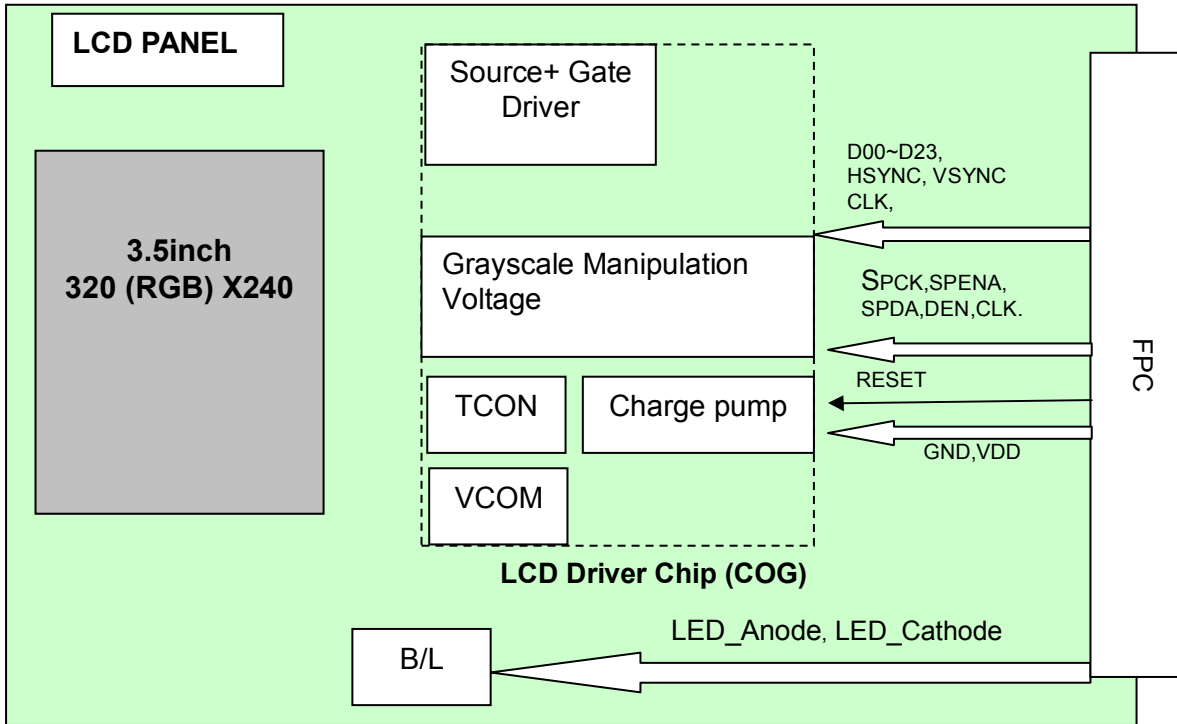

5 Timing Chart

5.1 24 bit RGB mode Input timing

5.1.1 RGB interface characteristics

(VDD=3.3V, GND= 0V,Ta=25°C)

Parameter	Symbol	Min	Typ	Max	Unit	Condition
CLK Pulse Duty	T_{clk}	40	50	60	%	
HSYNC Width	T_{hw}	2	--	--	DCLK	
VSYNC Setup Time	T_{vst}	12	--	--	ns	
VSYNC Hold Time	T_{vhd}	12	--	--	ns	
HSYNC Setup Time	T_{hst}	12	--	--	ns	
HSYNC Hold Time	T_{hhd}	12	--	--	ns	
Data Setup Time	T_{dsu}	12	--	--	ns	
Data Hold Time	T_{dhd}	12	--	--	ns	
DE Setup Time	T_{dest}	12	--	--	ns	
DE Hold Time	T_{dehd}	12	--	--	ns	

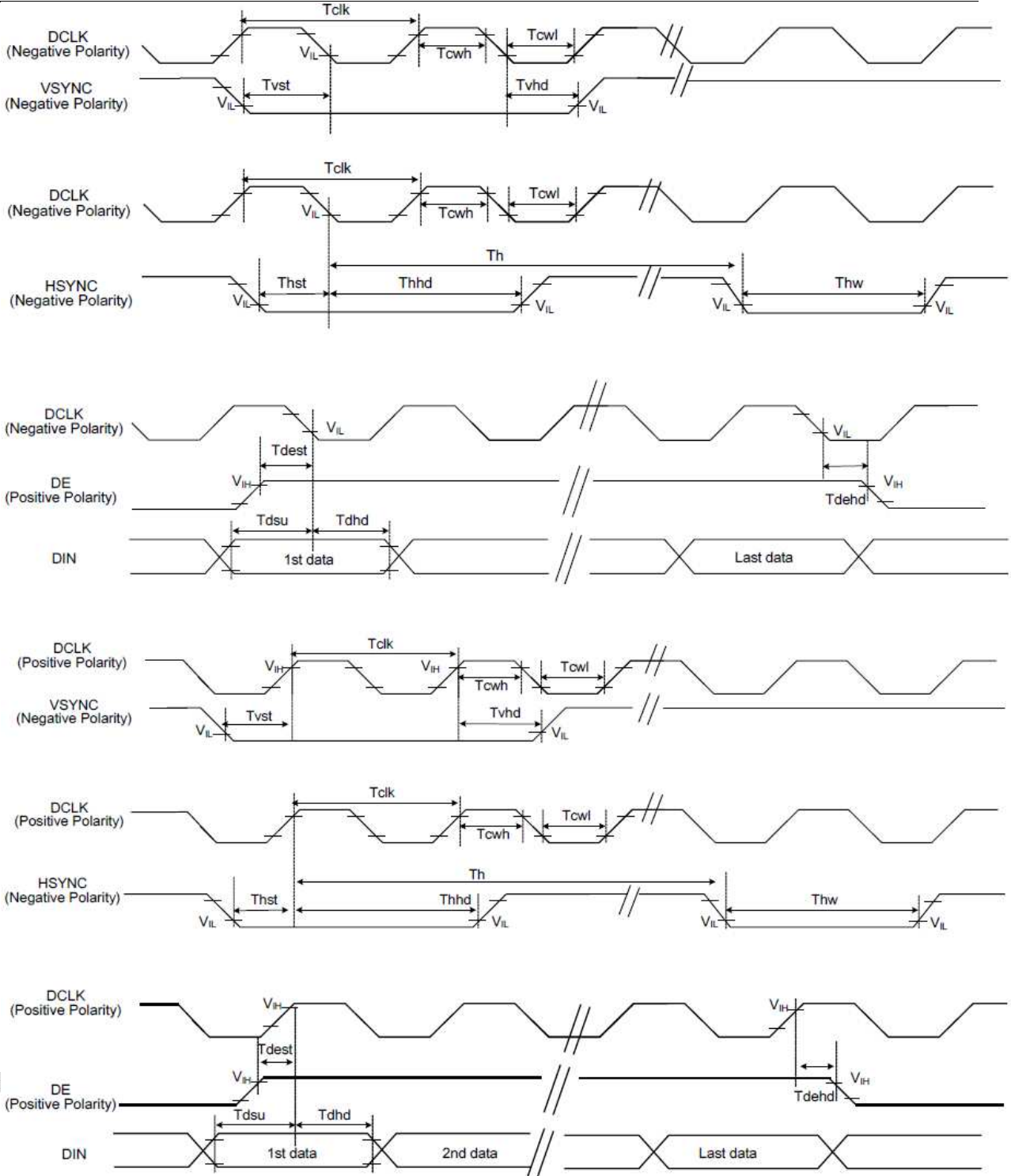

5.1.2 System Bus Timing for RGB Interface
(VDD=3.3V, GND= 0V,Ta=25°C)

Parameter	Symbol	Min	Typ	Max	Unit	Condition
DCLK Frequency	Fclk	5	6	8	MHz	
DCLK Period	Tclk	125	167	200	ns	
HSYNC	Period Time	Th	325	371	438	DCLK
	Display Period	Thdisp		320		DCLK
	Back Porch	Thbp	3	43	43	DCLK
	Front Porch	Thfp	2	8	75	DCLK
	Pulse Width	Thw	2	4	43	DCLK
VSYNC	Period Time	Tv	244	260	289	HSYNC
	Display Period	Tvdisp		240		HSYNC
	Back Porch	Tvbp	2	12	12	HSYNC
	Front Porch	Tvfp	2	8	37	HSYNC
	Pulse Width	Tvw	2	4	12	HSYNC

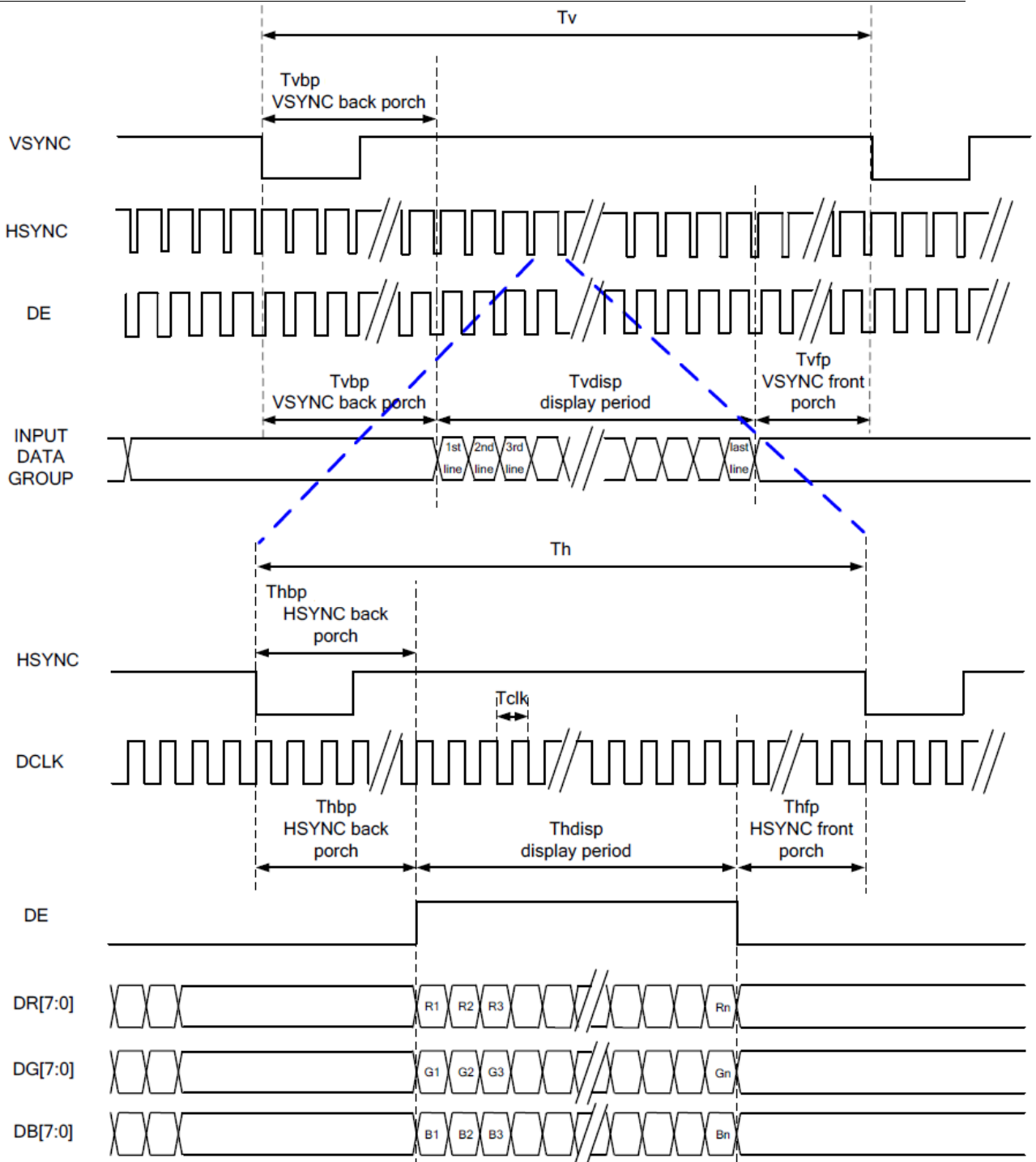

5.2 3-Wire SPI Interface Input timing

5.2.1 3-Wire SPI Interface characteristics

Parameter	Symbol	Min	Typ	Max	Unit	Remark
CS Input Setup Time	T_{s0}	50	--	--	ns	
Serial Data Input Setup Time	T_{s1}	50	--	--	ns	
CS Input Hold Time	T_{h0}	50	--	--	ns	
Serial Data Input Hold Time	T_{h1}	50	--	--	ns	
SCL Write Pulse High Width	T_{wh1}	50	--	--	ns	
SCL Write Pulse Low Width	T_{wl1}	50	--	--	ns	
SCL Read Pulse High Width	T_{rh1}	300	--	--	ns	
SCL Read Pulse Low Width	T_{rl1}	300	--	--	ns	
CS Pulse High Width	T_{w2}	400			ns	

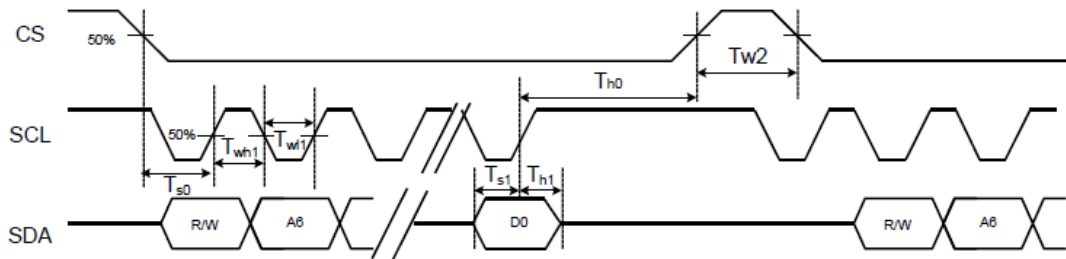

5.2.2 3-Wire SPI interface protocol

R/W: Read/Write mode control bit.

R/W=1: Read mode

R/W=0: Write mode

Read Mode

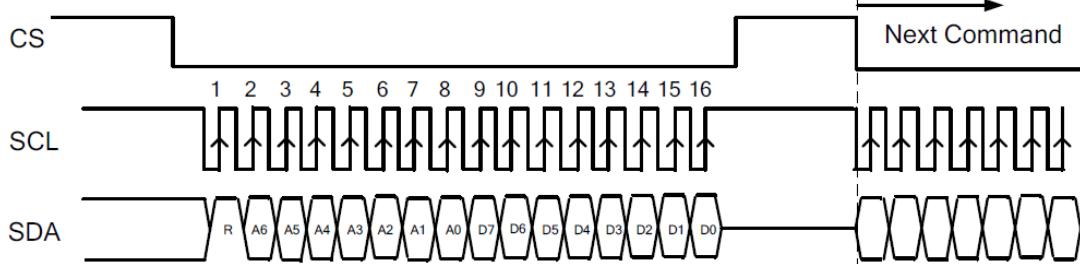

Write Mode

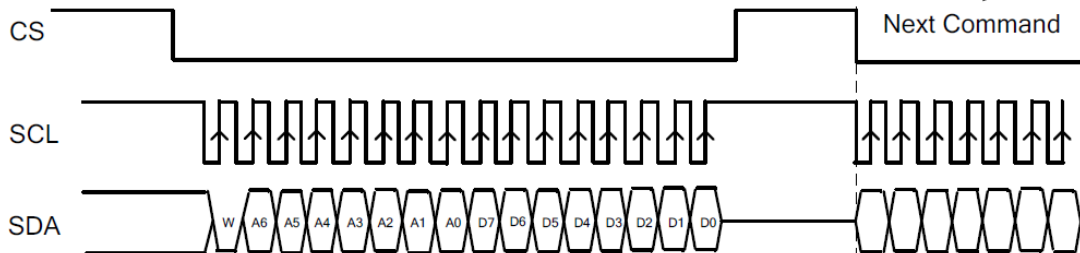

The information contained herein is the exclusive property of SHANGHAI TIANMA MICRO-ELECTRONICS Corporation, and shall not be distributed, reproduced, or disclosed in whole or in part without prior written permission of SHANGHAI TIANMA MICRO-ELECTRONICS Corporation.

5.3 Power On Sequence

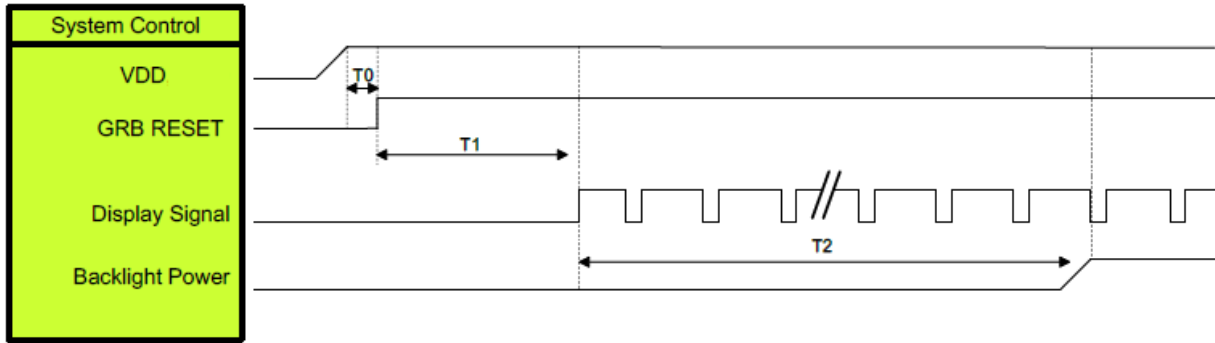

Symbol	Description	Min. Time	Unit
T0	System power stability to GRB RESET signal	0	ms
T1	GRB RESET= "High" to Display Signal output	10	ms
T2	Display Signal output to Backlight Power on	250	ms

Note: Display signal: DCLK; VSYNC; HSYNC; DE; DR[7:0]; DG[7:0]; DB[7:0]

5.4 Power off Sequence

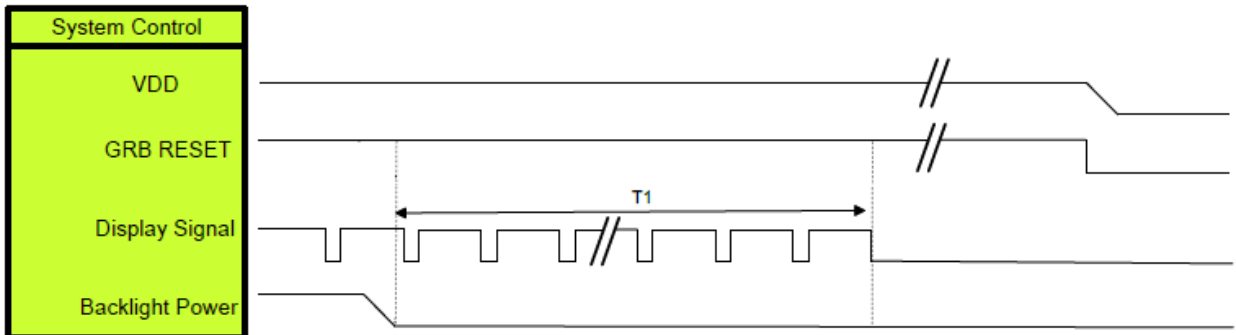

Symbol	Description	Min. Time	Unit
T1	Backlight Power off to IC internal voltage discharge complete	80	ms

Note: Display signal: DCLK; VSYNC; HSYNC; DE; DR[7:0]; DG[7:0]; DB[7:0]

6 Optical Characteristics

6.1 Optical Specification

Ta=25°C

Item	Symbol	Condition	Min	Typ.	Max.	Unit	Remark
View Angles	θT	$CR \geq 10$	70	80	--	Degree	Note 2
	θB		70	80	--		
	θL		70	80	--		
	θR		70	80	--		
Contrast Ratio	CR	$\theta=0^\circ$	600	800	--		Note1 Note3
Response Time	T_{ON}	25°C	--	25	35	ms	Note1 Note4
	T_{OFF}						
Chromaticity	White	x	Backlight is on	0.263	0.313	0.363	Note5, Note1
		y		0.287	0.337	0.387	
	Red	x		0.578	0.628	0.678	
		y		0.306	0.356	0.406	
	Green	x		0.293	0.343	0.393	
		y		0.537	0.587	0.637	
	Blue	x		0.097	0.147	0.197	
		y		0.040	0.090	0.140	
Uniformity	U		75	80	--	%	Note1 Note6
NTSC			55	60	--	%	Note 5
Luminance	L		300	350	--	cd/m ²	Note1 Note7

Test Conditions:

1. $V_F = 3V$, $I_F = 20mA$ (LED current), the ambient temperature is 25°C.
2. The test systems refer to Note 1 and Note2.

Note 1: Definition of optical measurement system.

The optical characteristics should be measured in dark room. After 5 minutes operation, the optical properties are measured at the center point of the LCD screen. All input terminals LCD panel must be ground when measuring the center area of the panel.

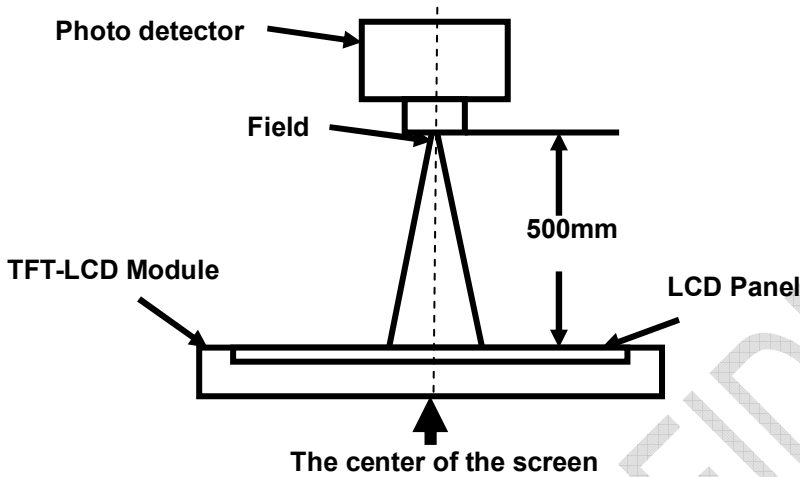

Note 2: Definition of viewing angle range and measurement system.

viewing angle is measured at the center point of the LCD by EZ-Contrast.

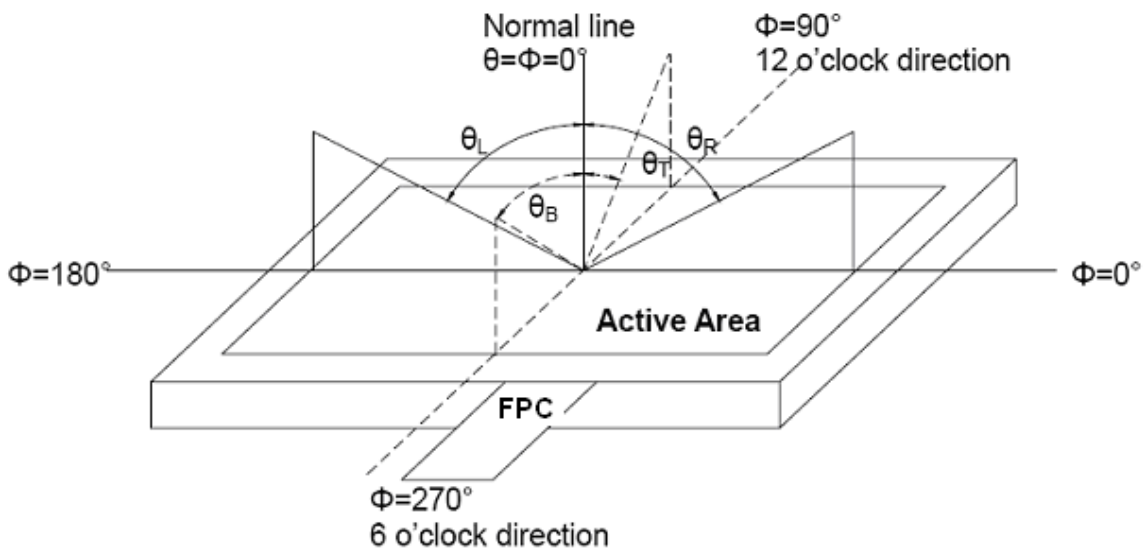

Fig. 1 Definition of viewing angle

Note 3: Definition of contrast ratio

$$\text{Contrast ratio (CR)} = \frac{\text{Luminance measured when LCD is on the "White" state}}{\text{Luminance measured when LCD is on the "Black" state}}$$

“White state “:The state is that the LCD should driven by Vwhite.

“Black state”: The state is that the LCD should driven by Vblack.

Vwhite: To be determined Vblack: To be determined.

Note 4: Definition of Response time

The response time is defined as the LCD optical switching time interval between “White” state and “Black” state. Rise time (TON) is the time between photo detector output intensity changed from 90% to 10%. And fall time (TOFF) is the time between photo detector output intensity changed from 10% to 90%.

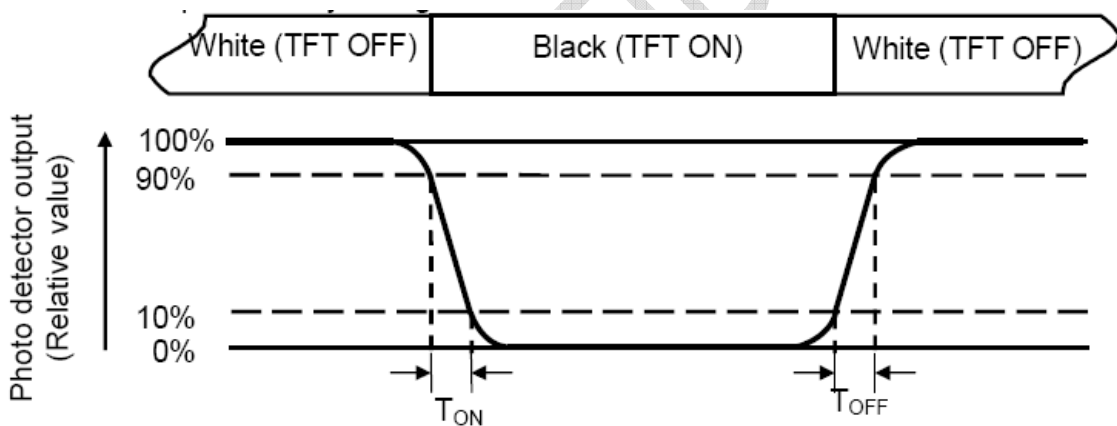

Note 5: Definition of color chromaticity (CIE1931)

Color coordinates measured at center point of LCD.

Note 6: Definition of Luminance Uniformity

Active area is divided into 9 measuring areas (Refer Fig. 2). Every measuring point is placed at the center of each measuring area.

$$\text{Luminance Uniformity}(U) = L_{\min} / L_{\max}$$

L-----Active area length W----- Active area width

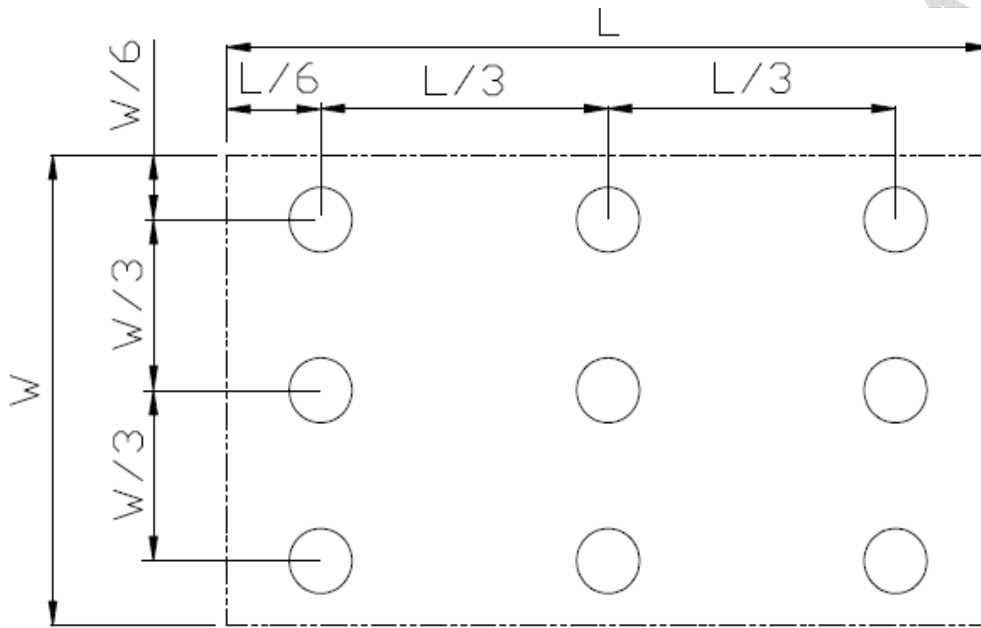

Fig. 2 Definition of uniformity

L_{\max} : The measured maximum luminance of all measurement position.

L_{\min} : The measured minimum luminance of all measurement position.

Note 7: Definition of Luminance :

Measure the luminance of white state at center point.

7 Environmental / Reliability Tests

No	Test Item	Condition	Remarks
1	High Temperature Operation	Ta=+70°C, 240hrs	IEC60068-2-1:2007,GB2423.2-2008
2	Low Temperature Operation	Ta=-20°C, 240hrs	IEC60068-2-1:2007 GB2423.1-2008
3	High Temperature Storage	Ta=+80°C, 240hrs	IEC60068-2-1:2007 GB2423.2-2008
4	Low Temperature Storage	Ta=-30°C, 240hrs	IEC60068-2-1:2007 GB2423.1-2008
5	Temperature & Humidity	Ta=60°C, 90% RH 240 hours	IEC60068-2-78 :2001 GB/T2423.3-2006
6	Thermal Shock (Non-operation)	-30°C 30 min~+80°C 30 min, Change time:5min, 100 Cycles	Start with cold temperature, End with high temperature, IEC60068-2-14:1984,GB2423.22-2012
7	Electro Static Discharge (Operation)	C=150pF, R=330Ω·5points/panel Air:±8KV, 5times; Contact:±4KV, 5 times; (Environment: 15°C~35°C, 30%~60%, 86Kpa~106Kpa)	IEC61000-4-2:2001 GB/T17626.2-2006
8	Vibration (Non-operation)	Frequency range : 10~55Hz Stroke : 1.5mm Sweep : 10Hz~55Hz~10Hz 2h for x,y,z (total 6h)	IEC60068-2-6:1982 GB/T2423.10-2008
9	Shock (Non-operation)	Half Sine Wave 60G ,6ms,±X,±Y,±Z 3times for each direction	IEC60068-2-27:1987 GB/T2423.5-1995
10	Package Drop Test	Height: TBD cm, 1 corner, 3 edges, 6 surfaces	GB/T 4857.5-1992

Note1: Ta is the ambient temperature of sample.

Note2: Before cosmetic and function test, the product must have enough recovery time, at least 2 hours at room temperature.

Note3: In the standard condition, there shall be no practical problem that may affect the display function. After the reliability test, the product only guarantees operation, but don't guarantee all of the cosmetic specification.

8 Mechanical Drawing

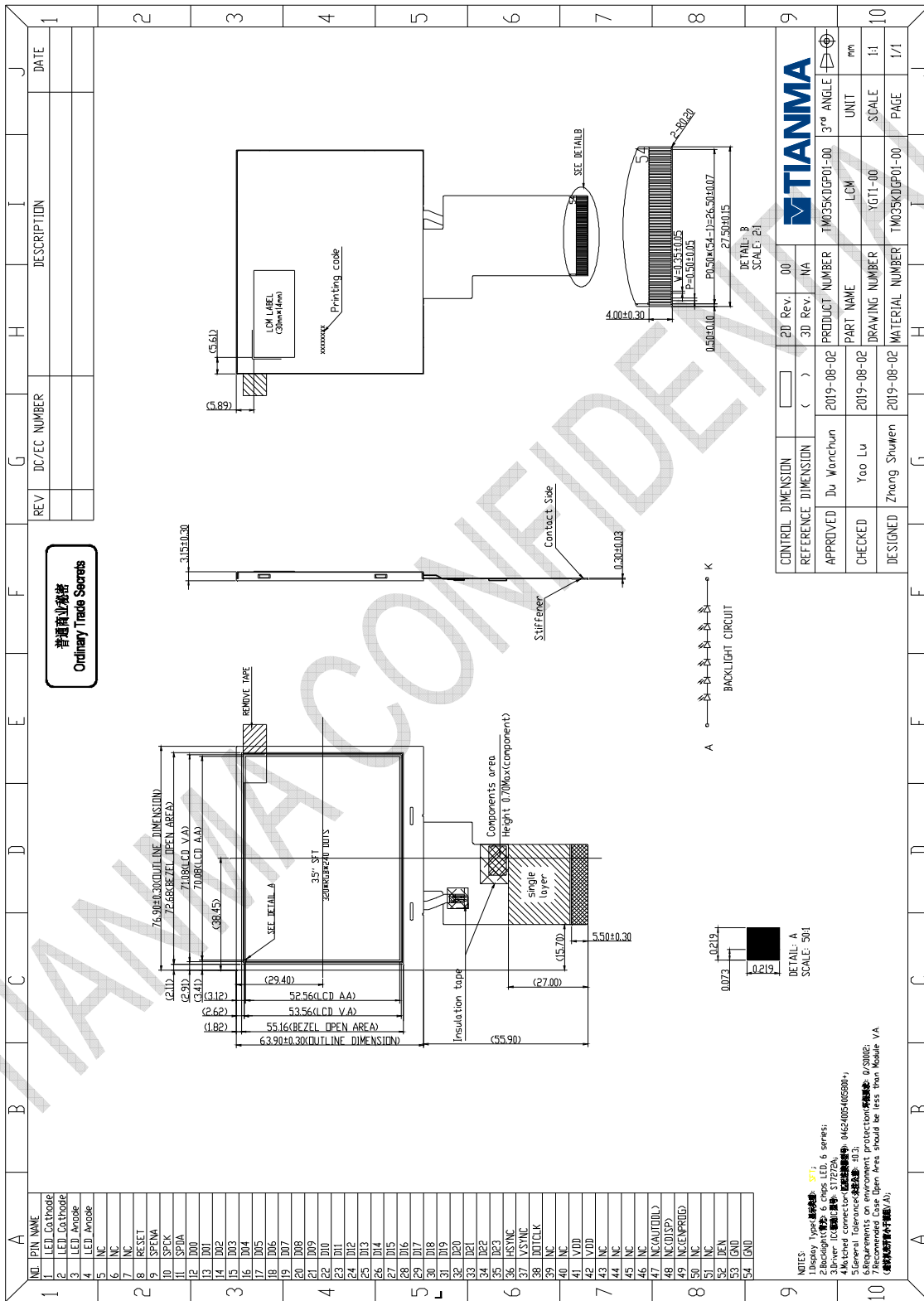

The information contained herein is the exclusive property of SHANGHAI TIANMA MICRO-ELECTRONICS Corporation, and shall not be distributed, reproduced, or disclosed in whole or in part without prior written permission of SHANGHAI TIANMA MICRO-ELECTRONICS Corporation.

9 Packing drawing

No	Item	Model (Material)	Dimensions(mm)	Unit Weight(Kg)	Quantity	Remark
1	LCM module	TM035KDGP01-00	76.90×63.90×3.15	TBD	252	
2	Dust-Proof Bag	PE	235×150×0.05mm	TBD	1	
3	Tray	PET	485×330×13.8	TBD	24	
4	Carton	Corrugated Paper	544×365×250	TBD	1	
5	BOX	Corrugated Paper	520×345×74	TBD	3	
6	Label	Paper	100*52	TBD	1	
7	Total weight	TBD ± 5%Kg				

Total LCM quantity in Carton: quantity per tray 12 × 21 tray = 252

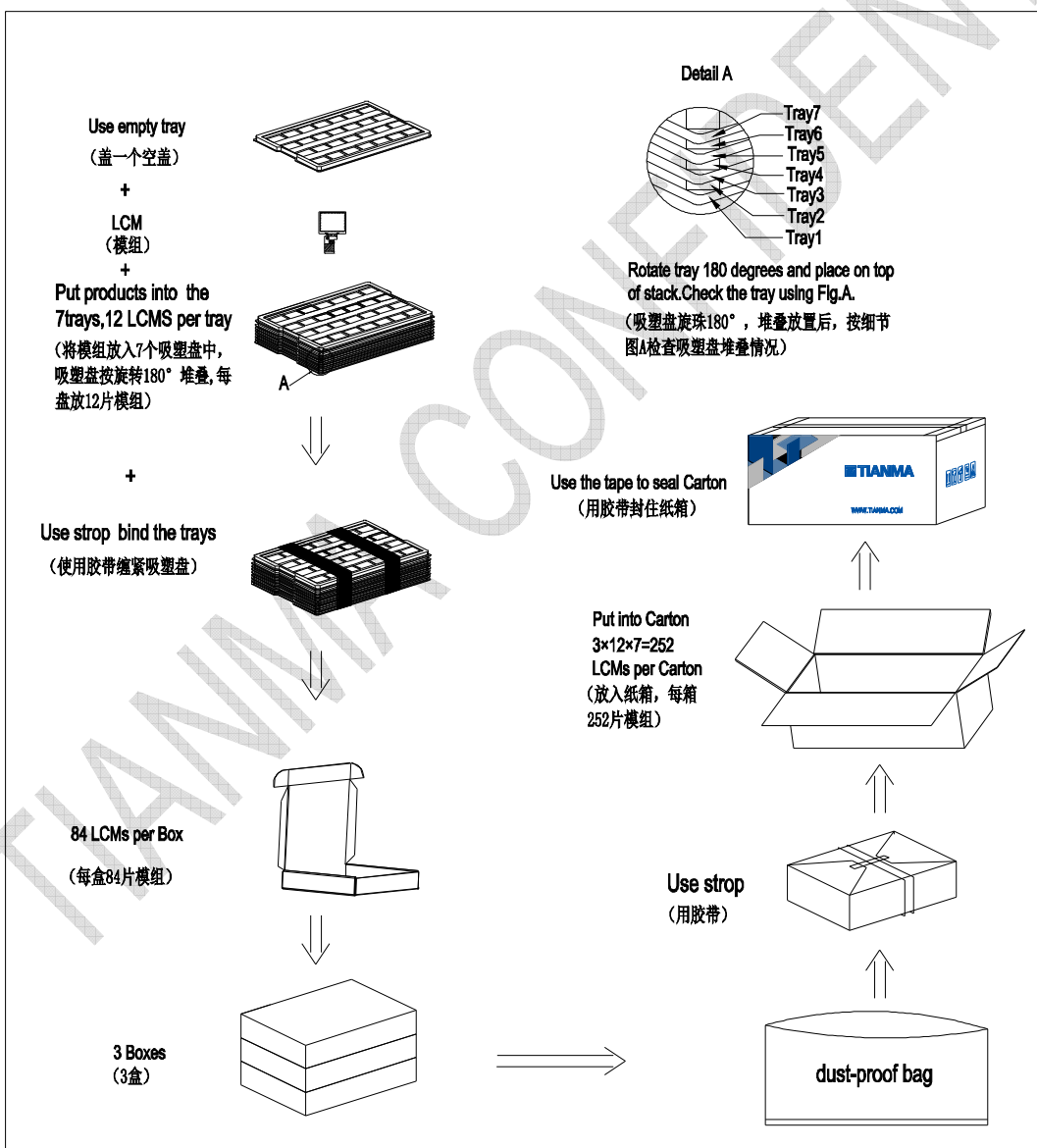

The information contained herein is the exclusive property of SHANGHAI TIANMA MICRO-ELECTRONICS Corporation, and shall not be distributed, reproduced, or disclosed in whole or in part without prior written permission of SHANGHAI TIANMA MICRO-ELECTRONICS Corporation.

纸箱堆叠数按 2*3/每层*共 5 层



10 Precautions For Use of LCD modules**10.1 Handling Precautions**

- 10.1.1. The display panel is made of glass. Do not subject it to a mechanical shock by dropping it from a high place, etc.
- 10.1.2. If the display panel is damaged and the liquid crystal substance inside it leaks out, be sure not to get any in your mouth, if the substance comes into contact with your skin or clothes, promptly wash it off using soap and water.
- 10.1.3. Do not apply excessive force to the display surface or the adjoining areas since this may cause the color tone to vary.
- 10.1.4. The polarizer covering the display surface of the LCD module is soft and easily scratched. Handle this polarizer carefully.
- 10.1.5. If the display surface is contaminated, breathe on the surface and gently wipe it with a soft dry cloth. If still not completely clear, moisten cloth with one of the following solvents:
- Isopropyl alcohol
 - Ethyl alcohol
- Solvents other than those mentioned above may damage the polarizer. Especially, do not use the following:
- Water
 - Ketone
 - Aromatic solvents
- 10.1.6. Do not attempt to disassemble the LCD Module.
- 10.1.7. If the logic circuit power is off, do not apply the input signals.
- 10.1.8. To prevent destruction of the elements by static electricity, be careful to maintain an optimum work environment.
- 10.1.8.1. Be sure to ground the body when handling the LCD Modules.
- 10.1.8.2. Tools required for assembly, such as soldering irons, must be properly ground.
- 10.1.8.3. To reduce the amount of static electricity generated, do not conduct assembly and other work under dry conditions.
- 10.1.8.4. The LCD Module is coated with a film to protect the display surface. Be care when peeling off this protective film since static electricity may be generated.

10.2 Storage Precautions

- 10.2.1. When storing the LCD modules, avoid exposure to direct sunlight or to the light of fluorescent lamps.
- 10.2.2. The LCD modules should be stored under the storage temperature range. If the LCD modules will be stored for a long time, the recommend condition is:
- Temperature : 0℃ ~ 40℃ Relatively humidity: ≤80%
- 10.2.3. The LCD modules should be stored in the room without acid, alkali and harmful gas.

10.3 Transportation Precautions

The LCD modules should be no falling and violent shocking during transportation, and also should avoid excessive press, water, damp and sunshine.