

**MODEL NO : TM043NDH02****MODEL VERSION: 40****SPEC VERSION : 2.4****ISSUED DATE: 2017-09-25**

- Preliminary Specification  
 Final Product Specification

Customer : \_\_\_\_\_

Approved by	Notes

TIANMA Confirmed :

Prepared by	Checked by	Approved by
Lifeng Chen	Xiaoxing Ding	Feng Qin

This technical specification is subjected to change without notice

## Table of Contents

Table of Contents .....	2
Record of Revision.....	3
1 General Specifications.....	4
2 Input/Output Terminals .....	5
3 Absolute Maximum Ratings.....	7
4 Electrical Characteristics .....	8
5 Timing Chart.....	10
6 Optical Characteristics .....	14
7 Environmental / Reliability Test.....	17
8 Mechanical Drawing .....	18
9 Packing Drawing .....	19
10 Precautions for Use of LCD Modules.....	21

## Record of Revision

Rev	Issued Date	Description	Editor
1.0	2015-04-20	Preliminary Specification Release	Hongkang Yan
2.0	2015-11-25	Update IC characteristics	Lifeng Chen
2.1	2016-04-07	Update LCM drawing	Lifeng Chen
2.2	2017-4-5	Update Led life time	Longping.Deng
2.3	2017-09-25	Update timing chart and power on/off sequence.	Gang.Li
2.4	2018-08-17	Update PIN definition and Block diagram	Zhengdong Liu

## 1 General Specifications

	Feature	Spec
<b>Display Spec.</b>	Size	4.3 inch
	Resolution	480(RGB)×272
	Technology Type	a-Si
	Pixel Configuration	Vertical Stripe
	Pixel pitch(mm)	0.198×0.198
	Display Mode	TN, Normally white
	Surface Treatment	AG
	Viewing Direction	6 o'clock
	Gray Scale Inversion Direction	12 o'clock
<b>Mechanical Characteristics</b>	LCM (W x H x D) (mm)	105.50×67.20×2.9
	Active Area(mm)	95.040×53.856
	With /Without TSP	Without TSP
	Matching Connection Type	FH19SC-40S-0.5SH(HIROS)
	LED Numbers	10 LEDS
	Weight (g)	44.4
<b>Electrical Characteristics</b>	Interface	RGB 24bits
	Color Depth	16.7M
	Driver IC	ST7282T2

Note 1: Viewing direction for best image quality is different from TFT definition. There is a 180 degree shift.

Note 2: Requirements on Environmental Protection: Q/S0002

Note 3: LCM weight tolerance: ± 5%

## 2 Input/Output Terminals

Matched connector:FH19SC-40S-0.5SH(HIROS)

Pin No.	Symbol	I/O	Function	Remark
1	VLED-	P	Back light cathode	
2	VLED+	P	Back light anode	
3	GND	P	Ground	
4	VDD	P	Power supply	
5	R0	I	Red Data input	
6	R1	I	Red Data input	
7	R2	I	Red Data input	
8	R3	I	Red Data input	
9	R4	I	Red Data input	
10	R5	I	Red Data input	
11	R6	I	Red Data input	
12	R7	I	Red Data input	
13	G0	I	Green Data input	
14	G1	I	Green Data input	
15	G2	I	Green Data input	
16	G3	I	Green Data input	
17	G4	I	Green Data input	
18	G5	I	Green Data input	
19	G6	I	Green Data input	
20	G7	I	Green Data input	
21	B0	I	Blue Data input	
22	B1	I	Blue Data input	
23	B2	I	Blue Data input	
24	B3	I	Blue Data input	
25	B4	I	Blue Data input	
26	B5	I	Blue Data input	
27	B6	I	Blue Data input	
28	B7	I	Blue Data input	
29	GND	P	Ground	

30	DCLK	I	Clock signal; latching data at the rising edge	
31	DISP	I	Display control/standby mode selection, Internal pull low DISP="Low": Standby; DISP="High": Normal display	
32	HSYNC	I	Horizontal sync signal; negative polarity	
33	VSYNC	I	Vertical sync signal; negative polarity	
34	DE	I	Data input enable. Active High to enable the data input When not used in SYNC mode, user should connect it to "Low".	
35	NC	-	No Connection	
36	GND	P	Ground	
37	NC	-	No Connection	
38	NC	-	No Connection	
39	NC	-	No Connection	
40	NC	-	No Connection	

Note1: Please add the FPC connector type and matched one if necessary .

Note2: I——Input, O——Output, P——Power/Ground

Note3: Display direction description



### 3 Absolute Maximum Ratings

GND=0V

Item	Symbol	MIN	MAX	Unit	Remark
Power Voltage	VCC	-0.3	4.6	V	Note1
Input voltage	V <sub>IN</sub>	-0.3	4.6	V	
Operating Temperature	Top	-20	70	°C	
Storage Temperature	Tst	-30	80	°C	
Relative Humidity Note2	RH	--	≤95	%	Ta≤40°C
		--	≤85	%	40°C < Ta ≤ 50°C
		--	≤55	%	50°C < Ta ≤ 60°C
		--	≤36	%	60°C < Ta ≤ 70°C
		--	≤24	%	70°C < Ta ≤ 80°C
Absolute Humidity	AH	--	≤70	g/m <sup>3</sup>	Ta>70°C

**Table 3 Absolute Maximum Ratings**

Note1: Input voltage include R0~R5, G0~G5, B0~B5, Dotclk, Hsync, Vsync, Enable, R/L, U/D

Note2: Ta means the ambient temperature.

It is necessary to limit the relative humidity to the specified temperature range.  
Condensation on the module is not allowed.

## 4 Electrical Characteristics

### 4.1 Driving TFT LCD Panel

Item	Symbol	MIN	TYP	MAX	Unit	Remark
Supply Voltage	VDD	3.0	3.3	3.6	V	
Input Signal Voltage	Low Level	$V_{IL}$	DGND	--	$0.3 \times VDD$	V
	High Level	$V_{IH}$	$0.7 \times VDD$	--	VDD	V
Output Signal Voltage	Low Level	$V_{OL}$	DGND	--	DGND+0.4	V
	High Level	$V_{OH}$	$VDD-0.4$	--	VDD	V
Power Consumption	60Hz	P	--	75	mW	Black pattern

### 4.2 Backlight Unit

Item	Symbol	MIN	TYP	MAX	Unit	Remark
Forward Current	$I_F$	--	40	50	mA	10 LEDs (2 LED Serial,5 LED Parallel)
Forward Current Voltage	$V_F$	-15	16	18	V	
Backlight Power Consumption	$W_{BL}$	--	640	--	mW	
LED life time	--	20000	30000	-	Hrs	

Note1: The LED driving condition is defined for each LED module (5 LED Serial,2 LED Parallel).

Note2: Under LCM operating, the stable forward current should be inputted. And forward voltage is for reference only.

Note3:  $I_F$  is defined for one channel LED. Optical performance should be evaluated at  $T_a=25^\circ\text{C}$  only if LED is driven by high current, high ambient temperature & Humidity condition. The life time of LED will be reduced. Operating life means brightness goes down to 50% initial brightness. Typical operating life time is estimated data.

Note4: The LED driving condition is defined for each LED module.

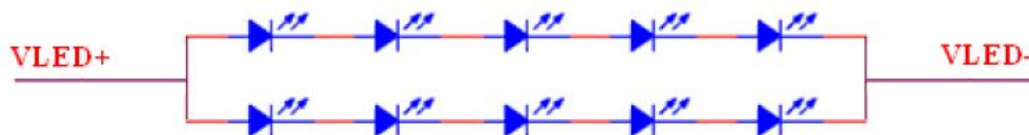
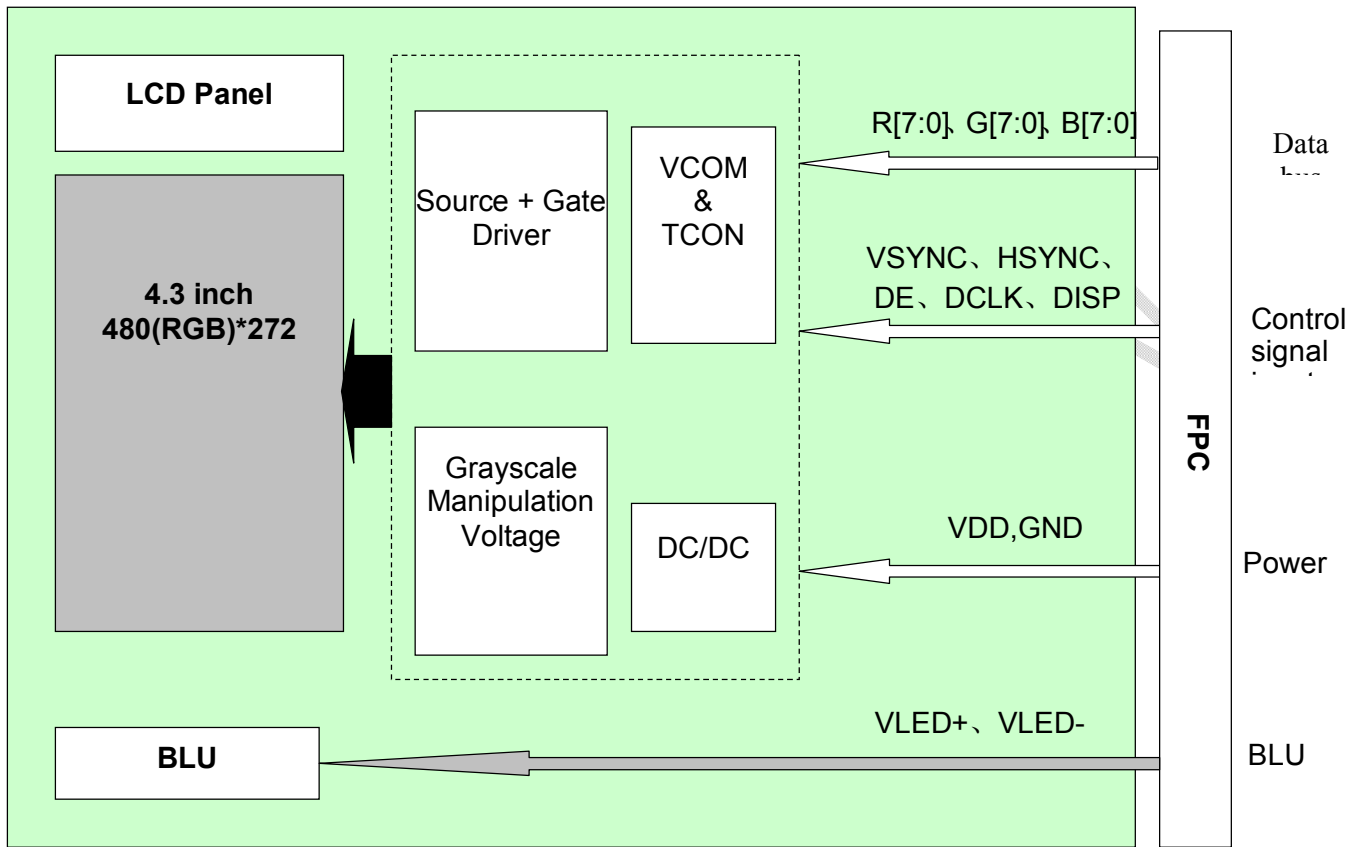

Figure 4.2 LED connection method



4.3 Block Diagram  
LCD Module diagram



TIANMA.COM

## 5 Timing Chart

### 5.1 AC characteristics

VDD=3.3V Ta=25°C

Parameter	Symbol	Min	Typ	Max	Unit	Remark
DCLK Pulse High Width	$T_{cwh}$	26.7	-	-	ns	
DCLK Pulse Low Width	$T_{cwl}$	26.7	-	-	ns	
DE Setup Time	$T_{dest}$	10	-	-	ns	
DE Hold Time	$T_{dehd}$	10	-	-	ns	
HSYNC Setup Time	$T_{hst}$	12	-	-	ns	
HSYNC Hold Time	$T_{hhd}$	12	-	-	ns	
VSYNC Setup Time	$T_{vst}$	12	-	-	ns	
VSYNC Hold Time	$T_{vhd}$	12	-	-	ns	
Data Setup Time	$T_{dsu}$	12	-	-	ns	
Data Hold Time	$T_{dhd}$	12	-	-	ns	

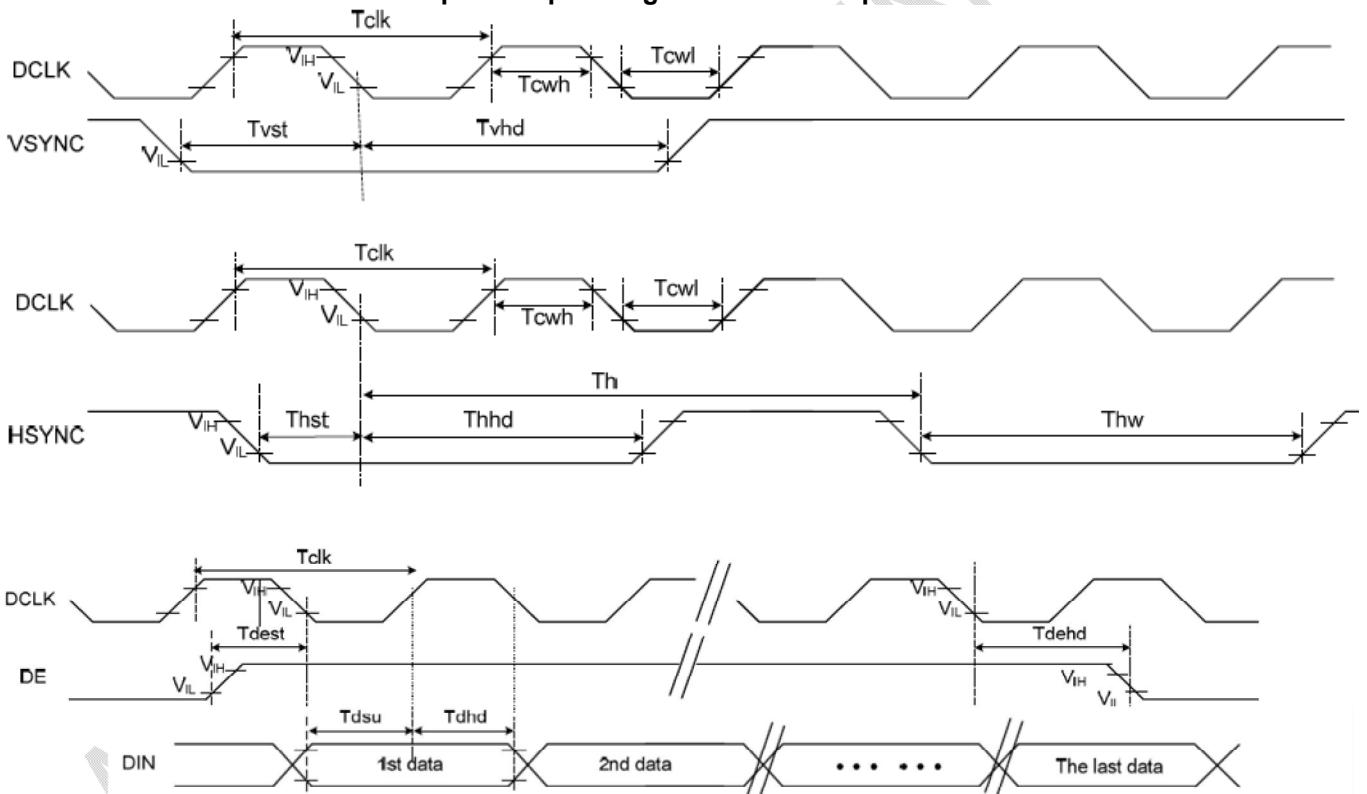
**Table 5.1 Input Setup Timing Parameters Requirement**

**Figure 5.1 Clock and Data Input Timing Diagram**

## 5.2 Data Input Timing Parameter Setting

Item	Symbol	Min.	Typ.	Max.	Unit	Remark	
DCLK Frequency	Fclk	8	9	12	MHz		
DCLK Period	Tclk	83	111	125	ns		
HSYNC	Period Time	Th	485	531	598	DCLK	
	Display Period	Thdisp		480		DCLK	
	Back Porch	Thbp	3	43	43	DCLK	By H_Blanking setting
	Front Porch	Thfp	2	8	75	DCLK	
	Pulse Width	Thw	2	4	75	DCLK	
VSYNC	Period Time	Tv	276	292	321	H	
	Display Period	Tvdisp		272		H	
	Back Porch	Tvbp	2	12	12	H	By V_Blanking setting
	Front Porch	Tvfp	2	8	37	H	
	Pulse Width	Tvw	2	4	37	H	

Note: It is necessary to keep Tvbp =12 and Thbp =43 in sync mode. DE mode is unnecessary to keep it.

Table 5.2 Data Input Timing Parameters

## 5.3 SYNC Mode Timing Diagram

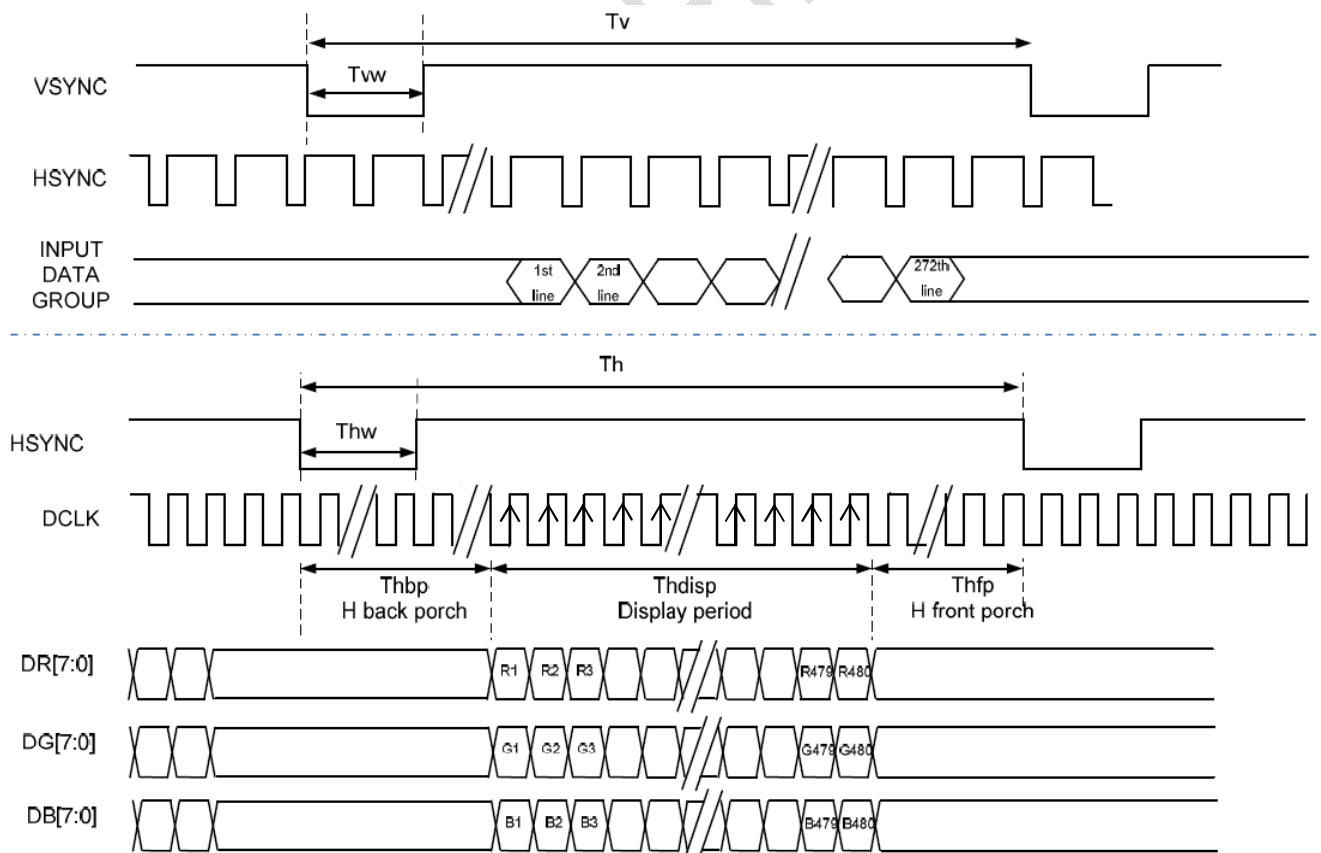
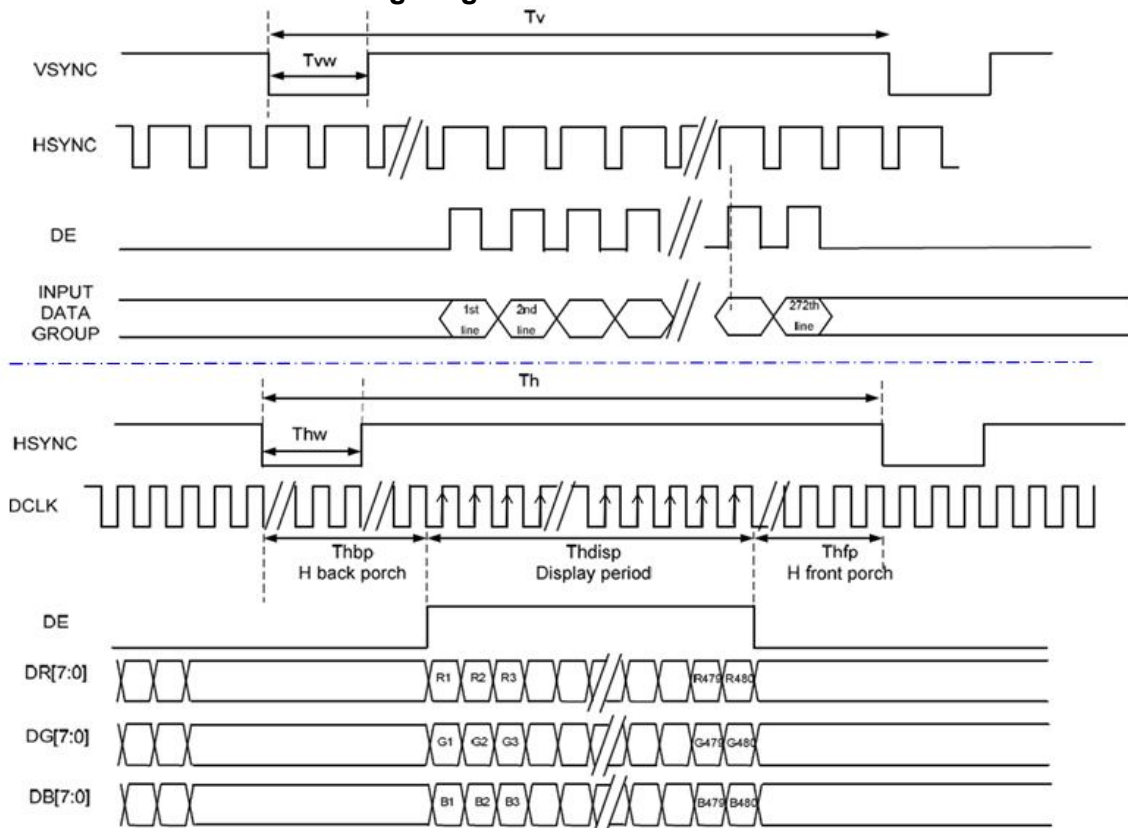

Figure 5.3 Data Input Timing Diagram Under SYNC Mode

The information contained herein is the exclusive property of TIANMA MICRO-ELECTRONICS Corporation and shall not be distributed, reproduced, or disclosed in whole or in part without prior written permission of TIANMA MICRO-ELECTRONICS Corporation.

**5.4 SYNC-DE Mode Timing Diagram**



**Figure 5.4 Data Input Timing Diagram Under SYNC-DE Mode**

**5.5 DE Mode Timing Diagram**

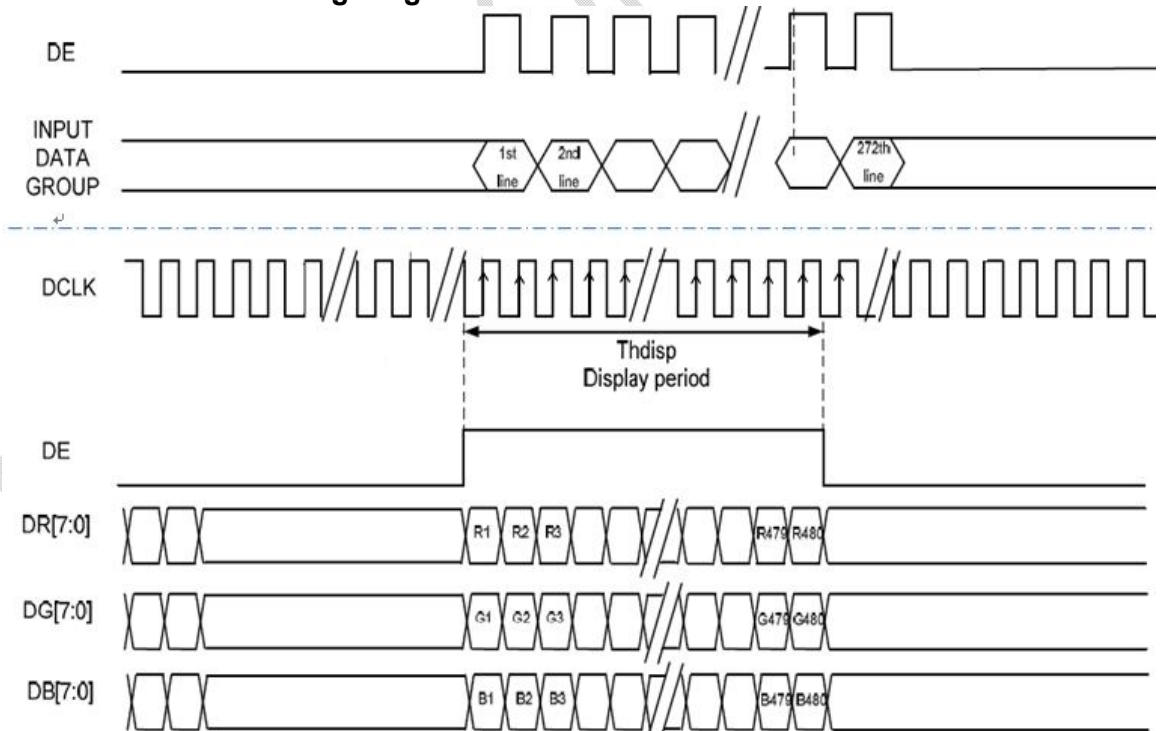
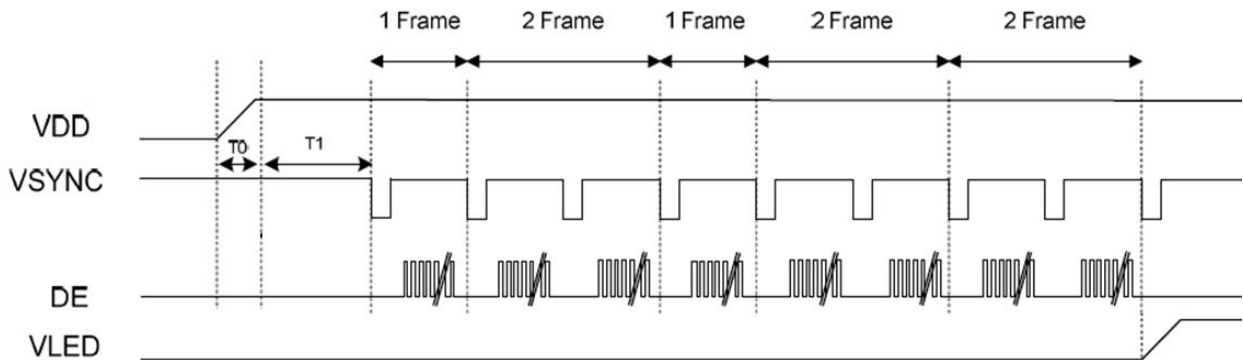

**Figure 5.5 Data Input Timing Diagram Under DE Mode**

The information contained herein is the exclusive property of TIANMA MICRO-ELECTRONICS Corporation and shall not be distributed, reproduced, or disclosed in whole or in part without prior written permission of TIANMA MICRO-ELECTRONICS Corporation.

## 5.6 Power ON/OFF Sequence

### 5.6.1 Power ON Sequence



**Figure 5.6.1 Power on sequence**

### 5.6.2 Power OFF Sequence

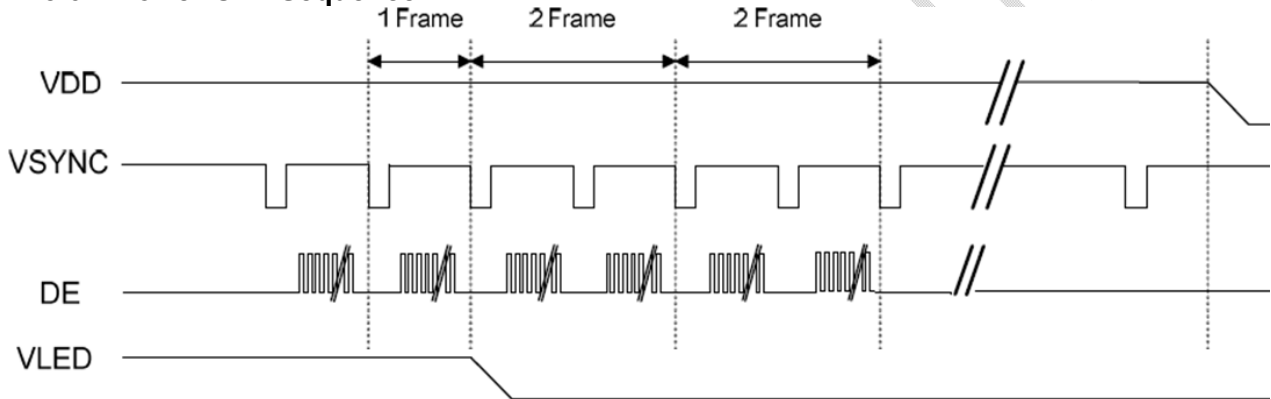

**Figure 5.6.2 Power off sequence**

**Note 1:**  $T_0$  is determined by the external power. The slow time should be set longer than 0ms and shorter than 20ms.

$T_1$  is the time from stable VDD to the first VSYNC, this value should be set longer than 0ms.

**Note 2:** When power on, VLED on should be set 8 frames( $16.7 \times 8 = 134\text{ms}$ )delayed to VDD on.

When power off, VLED off should be set at least 4 frames( $16.7 \times 4 = 67\text{ms}$ )before VDD off.

## 6 Optical Characteristics

Item	Symbol	Condition	Min	Typ	Max	Unit	Remark
<b>View Angles</b>	$\theta T$	$CR \geq 10$	70	80	-	Degree	Note2,3
	$\theta B$		50	60	-		
	$\theta L$		70	80	-		
	$\theta R$		70	80	-		
<b>Contrast Ratio</b>	CR	$\theta=0^\circ$	700	900	-		Note 3
<b>Response Time</b>	$T_{ON}$	25°C	-	20	30	ms	Note 4
	$T_{OFF}$						
<b>Chromaticity</b>	<b>White</b>	x	Backlight is on	0.255	0.305	0.355	Note 1,5
		y		0.277	0.327	0.377	
	<b>Red</b>	x		0.534	0.584	0.634	Note 1,5
		y		0.300	0.350	0.400	
	<b>Green</b>	x		0.290	0.340	0.390	Note 1,5
		y		0.543	0.593	0.643	
	<b>Blue</b>	x		0.102	0.152	0.202	Note 1,5
		y		0.040	0.090	0.140	
<b>Uniformity</b>	U		75	80	-	%	Note 6
<b>NTSC</b>			45	50	-	%	Note 5
<b>Luminance</b>	L		350	400	-	cd/m <sup>2</sup>	Note 7

Test Conditions:

1.  $I_F = 40$  mA, and the ambient temperature is 25°C.
2. The test systems refer to Note 1 and Note 2.

Note 1: Definition of optical measurement system.

The optical characteristics should be measured in dark room. After 5 Minutes operation, the optical properties are measured at the center point of the LCD screen. All input terminals LCD panel must be ground when measuring the center area of the panel.

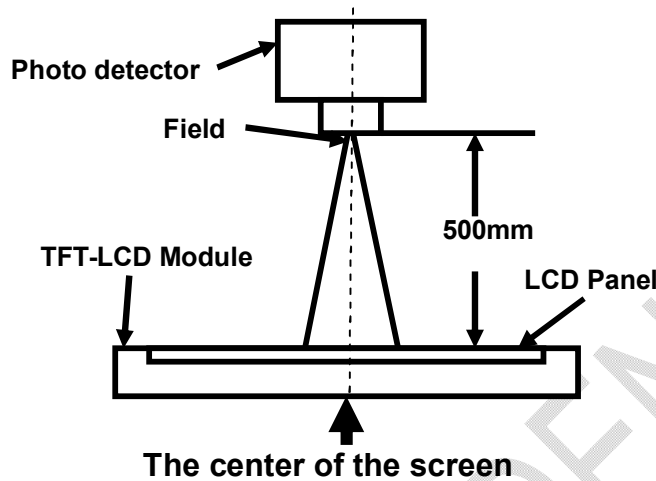

Note 2: Definition of viewing angle range and measurement system.

viewing angle is measured at the center point of the LCD by CONOSCOPE(ergo-80).

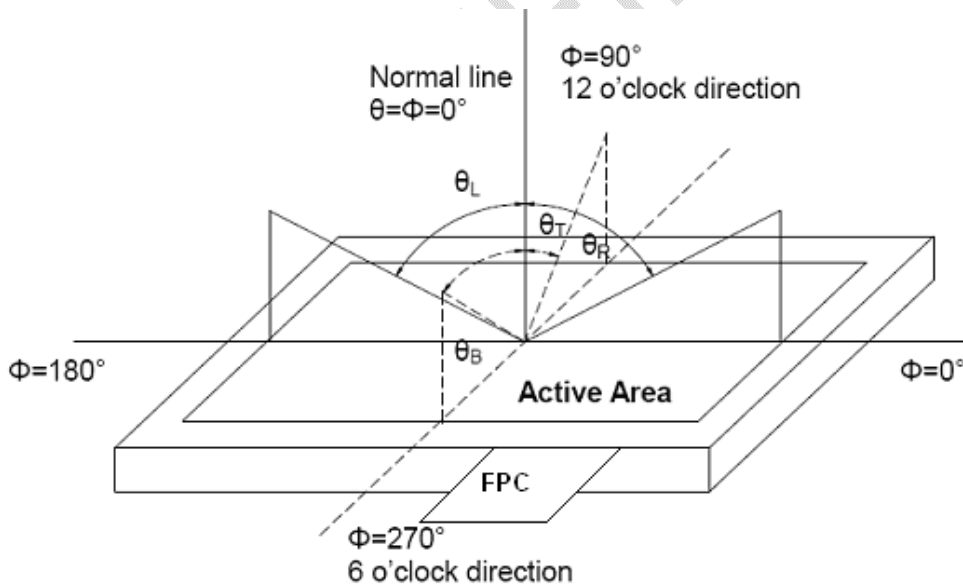

Note 3: Definition of contrast ratio

$$\text{Contrast ratio (CR)} = \frac{\text{Luminance measured when LCD is on the "White" state}}{\text{Luminance measured when LCD is on the "Black" state}}$$

“White state “: The state is that the LCD should drive by  $V_{white}$ .

“Black state”: The state is that the LCD should drive by  $V_{black}$ .

$V_{white}$ : To be determined     $V_{black}$ : To be determined.

Note 4: Definition of Response time

The response time is defined as the LCD optical switching time interval between “White” state and “Black” state. Rise time ( $T_{ON}$ ) is the time between photo detector output intensity changed from 90% to 10%. And fall time ( $T_{OFF}$ ) is the time between photo detector output intensity changed from 10% to 90%.

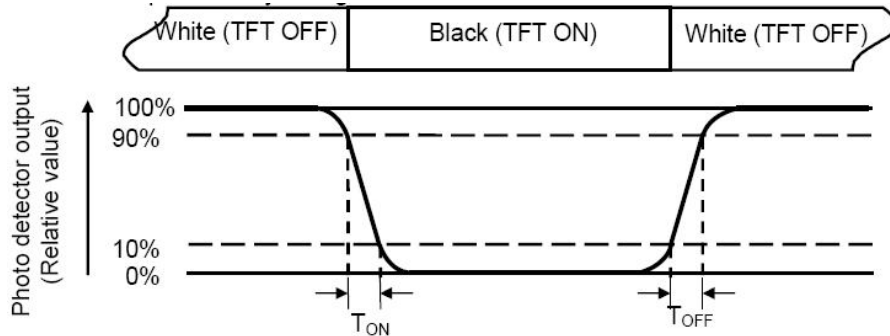

Note 5: Definition of color chromaticity (CIE1931)

Color coordinates measured at center point of LCD.

Note 6: Definition of Luminance Uniformity

Active area is divided into 9 measuring areas (Refer Fig. 2). Every measuring point is placed at the center of each measuring area.

$$\text{Luminance Uniformity (U)} = L_{\min} / L_{\max}$$

L-----Active area length W----- Active area width

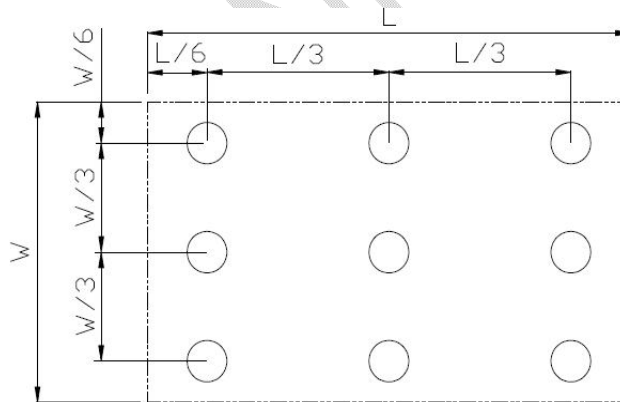

$L_{\max}$ : The measured Maximum luminance of all measurement position.

$L_{\min}$ : The measured Minimum luminance of all measurement position.

Note 7: Definition of Luminance:

Measure the luminance of white state at center point.



**7 Environmental / Reliability Test**

No	Test Item	Condition	Remarks
1	High Temperature Operation	Ts=+70℃, 240 hours	IEC60068-2-1:2007 GB2423.2-2008
2	Low Temperature Operation	Ta=-20℃, 240 hours	IEC60068-2-1:2007 GB2423.1-2008
3	High Temperature Storage	Ta=+80℃, 240 hours	IEC60068-2-1:2007 GB2423.2-2008
4	Low Temperature Storage	Ta=-30℃, 240 hours	IEC60068-2-1:2007 GB2423.1-2008
5	Storage at High Temperature and Humidity	Ta=+60℃, 90% RH 240 hours	IEC60068-2-78 :2001 GB/T2423.3—2006
6	Thermal Shock (non-operation)	-20℃ 30min ~+80℃ 30min, Change time: 5min, 20 cycles	Start with cold temperature, End with high temperature, IEC60068-2-14:1984,G B2423.22-2002
7	ESD	C=150pF,R=330Ω, 5 point/panel, Air: ±8KV, 5 times; Contact ±4KV,5times (Environment:15℃ ~35℃,30%~60%,80Kpa~106Kpa)	IEC61000-4-2:2001 GB/T17626.2-2006
8	Vibration Test	Frequency range:10~55Hz Stroke:1.5mm Sweep:10Hz~55Hz~10Hz 2 hours for each direction of X.Y.Z(6 hours for total)(package condition)	IEC60068-2-6:1982 GB/T2423.10—1995
9	Mechanical Shock (Non OP)	60G 6ms, ±X, ±Y, ±Z 3 times for each direction	IEC60068-2-27:1987 GB/T2423.5—1995
10	Package Drop Test	Height:80cm,1corner,3edges,6surfaces	IEC60068-2-32:1990 GB/T2423.8—1995

Note1: Ts is the temperature of panel's surface.

Note2: Ta is the ambient temperature of sample.

Note3: Before cosmetic and function test, the product must have enough recovery time, at least 2 hours at room temperature.

Note 4: In the standard condition, there shall be no practical problem that may affect the display function. After the reliability test, the product only guarantees operation, but don't guarantee all of the cosmetic specification.

# 8 Mechanical Drawing

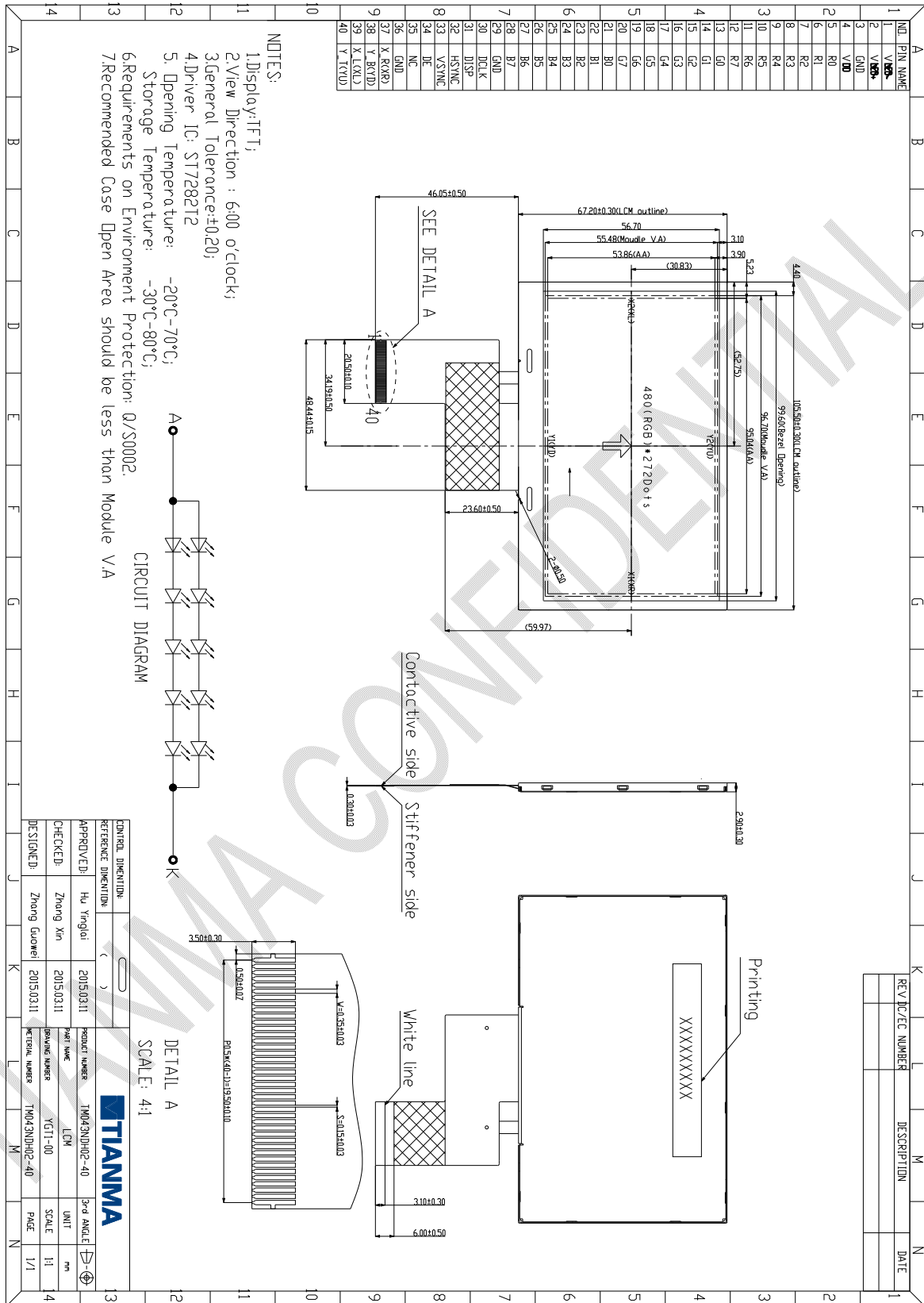

The information contained herein is the exclusive property of TIANMA MICRO-ELECTRONICS Corporation and shall not be distributed, reproduced, or disclosed in whole or in part without prior written permission of TIANMA MICRO-ELECTRONICS Corporation.

**9 Packing Drawing**  
**Per Carton**

No	Item	Model (Material)	Dimensions(m m)	Unit Weight(Kg)	Quantity	Remark
1	LCM module	TM043NDH02	105.5×67.20×2. 90	58.7	144	
2	Tray	PET (Transmit)	485×330×13.8	0.14	27	
3	Dust Proof Bag	PE	700×545mm	0.046	1	
4	BOX	CORRUGATED PAPER	520×345×74	0.44	3	
5	Carton	CORRUGATED PAPER	544×365×250	1.01	1	
6	Total weight	8 Kg ± 5%Kg				

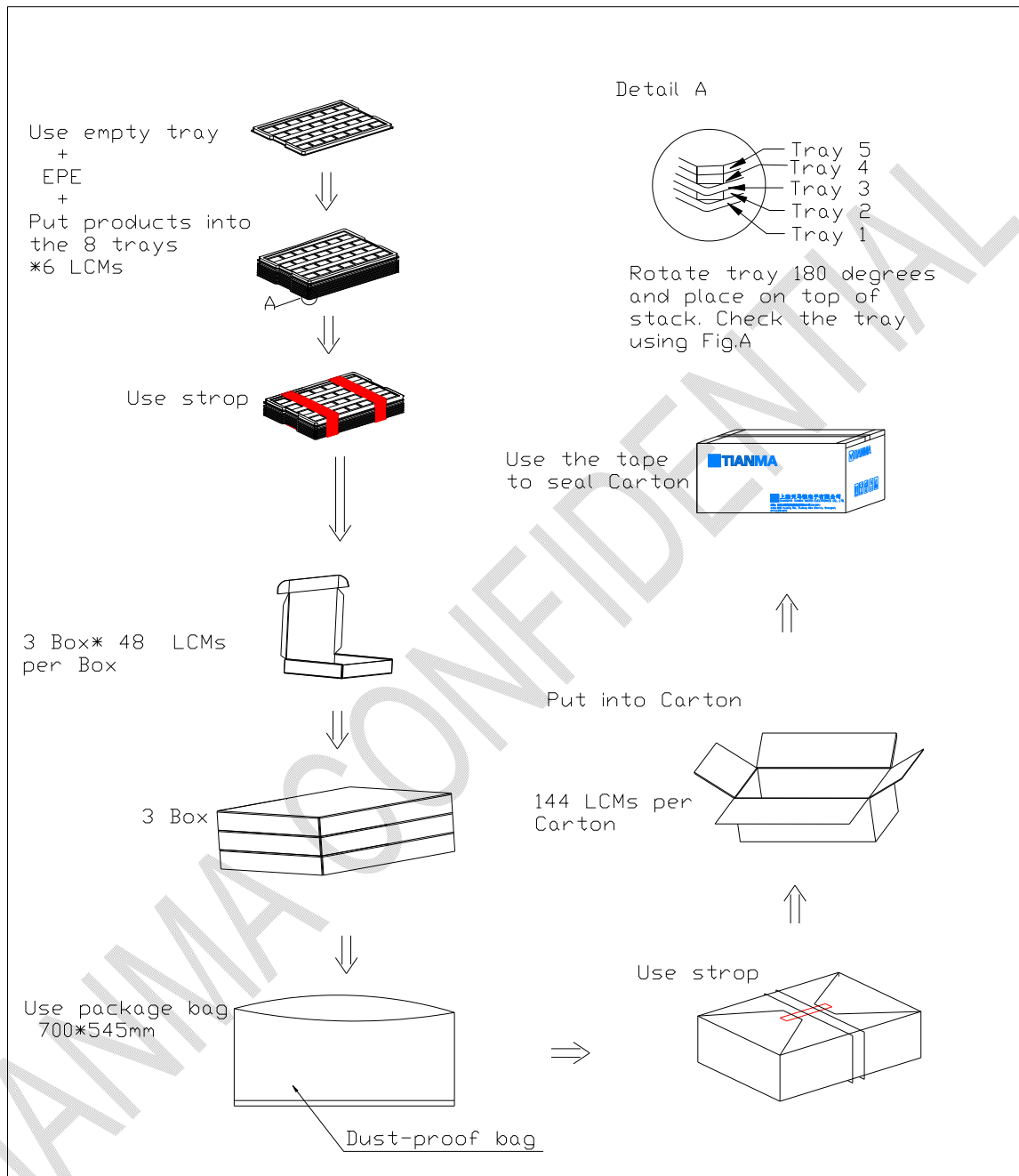

纸箱堆叠数按2\*3/每层\*共5层

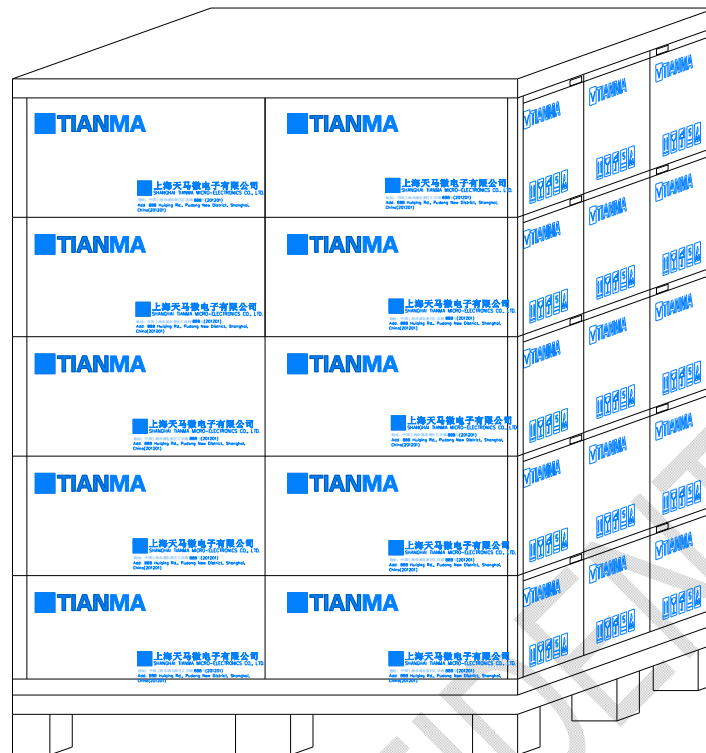

## 10 Precautions for Use of LCD Modules

### 10.1 Handling Precautions

10.1.1 The display panel is made of glass. Do not subject it to a mechanical shock by dropping it from a high place, etc.

10.1.2 If the display panel is damaged and the liquid crystal substance inside it leaks out, be sure not to get any in your mouth, if the substance comes into contact with your skin or clothes, promptly wash it off using soap and water.

10.1.3 Do not apply excessive force to the display surface or the adjoining areas since this may cause the color tone to vary.

10.1.4 The polarizer covering the display surface of the LCD module is soft and easily scratched. Handle this polarizer carefully.

10.1.5 If the display surface is contaminated, breathe on the surface and gently wipe it with a soft dry cloth. If still not completely clear, moisten cloth with one of the following solvents:

The information contained herein is the exclusive property of TIANMA MICRO-ELECTRONICS Corporation and shall not be distributed, reproduced, or disclosed in whole or in part without prior written permission of TIANMA MICRO-ELECTRONICS Corporation.

- Isopropyl alcohol
- Ethyl alcohol

Solvents other than those mentioned above may damage the polarizer. Especially, do not use the following:

- Water
- Ketone
- Aromatic solvents

10.1.6 Do not attempt to disassemble the LCD Module.

10.1.7 If the logic circuit power is off, do not apply the input signals.

10.1.8 To prevent destruction of the elements by static electricity, be careful to maintain an optimum work environment.

10.1.8.1 Be sure to ground the body when handling the LCD Modules.

10.1.8.2 Tools required for assembly, such as soldering irons, must be properly ground.

10.1.8.3 To reduce the amount of static electricity generated, do not conduct assembly and other work under dry conditions.

10.1.8.4 The LCD Module is coated with a film to protect the display surface. Be care when peeling off this protective film since static electricity may be generated.

## 10.2 Storage precautions

10.2.1 When storing the LCD modules, avoid exposure to direct sunlight or to the light of fluorescent lamps.

10.2.2 The LCD modules should be stored under the storage temperature range. If the LCD modules will be stored for a long time, the recommend condition is:

Temperature : 0°C ~ 40°C Relatively humidity: ≤80%

10.2.3 The LCD modules should be stored in the room without acid, alkali and harmful gas.

## 10.3 Transportation Precautions

10.3.1 The LCD modules should be no falling and violent shocking during transportation, and also should avoid excessive press, water, damp and sunshine.