



( V ) Preliminary Specifications  
 ( ) Final Specifications

<b>Module</b>	12.1 Inch Color TFT-LCD
<b>Model Name</b>	G121STN02.0

<b>Customer</b>	<b>Date</b>
<p style="text-align: center;"><b>Checked &amp; Approved by</b></p> <p>_____</p>	<p>_____</p>
<p>Note: This Specification is subject to change without notice.</p>	

<b>Approved by</b>	<b>Date</b>
<p>_____ Grace Hung</p>	<p>_____ 2019/01/18</p>
<b>Prepared by</b>	
<p>_____ Ivan Chao</p>	<p>_____ 2019/01/18</p>
<p>General Display Business Division / AU Optronics corporation</p>	

## Contents

<b>1. Operating Precautions .....</b>	<b>5</b>
<b>2. General Description .....</b>	<b>6</b>
2.1 Display Characteristics .....	6
2.2 Optical Characteristics .....	7
<b>3. Functional Block Diagram .....</b>	<b>10</b>
<b>4. Absolute Maximum Ratings.....</b>	<b>11</b>
4.1 Absolute Ratings of TFT LCD Module.....	11
4.2 Absolute Ratings of Environment.....	11
<b>5. Electrical Characteristics.....</b>	<b>12</b>
5.1 TFT LCD Module .....	12
5.2 Backlight Unit.....	14
<b>6. Signal Characteristics.....</b>	<b>15</b>
6.1 Pixel Format Image.....	15
6.2 Scanning Direction.....	15
6.3 TFT-LCD Interface Signal Description .....	16
6.4 The Input Data Format.....	17
6.5 TFT-LCD Interface Timing.....	18
6.6 Power ON/OFF Sequence .....	19
<b>7. Connector &amp; Pin Assignment .....</b>	<b>20</b>
7.1 TFT-LCD Signal (CN1): LCD Connector .....	20
7.2 LED Backlight Unit (CN2): Driver Connector .....	20
7.3 LED Backlight Unit: Light bar Connector.....	21
<b>8. Reliability Test Criteria.....</b>	<b>22</b>
<b>9. Mechanical Characteristics .....</b>	<b>23</b>
9.1 LCM Outline Dimension (Front View).....	23
9.2 LCM Outline Dimension (Rear View) .....	24
<b>10. Label and Packaging.....</b>	<b>25</b>
10.1 Shipping Label (on the rear side of TFT-LCD display) .....	25
10.2 Carton Package .....	25
11.1 Sharp Edge Requirements.....	26
11.2 Materials.....	26
11.3 Capacitors .....	26
11.4 National Test Lab Requirement.....	26

Record of Revision

Version and Date	Page	Old description	New Description																																																																																												
0.0 2018/7/12	All	First Edition																																																																																													
0.1 2018/7/18	5 6 24		Weight: TBD Chromaticity: R,G,B: TBD Packing: Capacity, Weight, Outline Dimension: TBD																																																																																												
0.2 2018/7/26	13	5.2.1 Parameter guideline for LCD <b>V<sub>EN</sub></b> EN Control Level BL On Min. 3V; <b>V<sub>PWM</sub></b> Dimming Control Level High Level Min. 3V	<b>V<sub>EN</sub></b> Min. 2.5V <b>V<sub>PWM</sub></b> Min. 2.5V																																																																																												
0.3 2018/9/17	24		Updated Shipping Label description																																																																																												
0.4 2018/12/20	5	Weight: [Grams] TBD (max)	Weight: [Grams] 600 (max)																																																																																												
	6	Color / Chromaticity Coordinates $\downarrow$ (CIE 1931)	Color / Chromaticity Coordinates $\downarrow$ (CIE 1931)																																																																																												
	24	Note: 1. Max. Capacity: <b>TBD</b> LCD Modules / per carton 2. Max. Weight: <b>TBD</b> kg / per carton 3. The outside dimension of carton is <b>TBD</b>	Note: 1. Max. Capacity: 20pcs LCD Modules / per carton 2. Max. Weight: 15.0 kg / per carton 3. The outside dimension of carton is 570(L) mm x 320(W) mm x 420(H) mm 4. Pallet: 1150mm*980mm*135mm (M17)																																																																																												
	11	<table border="1"> <thead> <tr> <th>Item</th> <th>Symbol</th> <th>Min</th> <th>Max</th> <th>Unit</th> </tr> </thead> <tbody> <tr> <td>Logic/LCD Drive Voltage</td> <td>VDD</td> <td>-0.3</td> <td>+3.8</td> <td>[Volt]</td> </tr> <tr> <td>Contort Signals</td> <td>SEL68, REVERSE</td> <td>-0.3</td> <td>VDD</td> <td>[Volt]</td> </tr> <tr> <td>LVDS Signals</td> <td>CLKIN -/+, RIN0 - 3/+</td> <td>-0.3</td> <td>VDD</td> <td>[Volt]</td> </tr> <tr> <td>LED Input Voltage</td> <td>VCC</td> <td>-0.3</td> <td>+13</td> <td>[Volt]</td> </tr> <tr> <td>LED Control Signals</td> <td>EN, PWM</td> <td>-0.3</td> <td>+6</td> <td>[Volt]</td> </tr> </tbody> </table>	Item	Symbol	Min	Max	Unit	Logic/LCD Drive Voltage	VDD	-0.3	+3.8	[Volt]	Contort Signals	SEL68, REVERSE	-0.3	VDD	[Volt]	LVDS Signals	CLKIN -/+, RIN0 - 3/+	-0.3	VDD	[Volt]	LED Input Voltage	VCC	-0.3	+13	[Volt]	LED Control Signals	EN, PWM	-0.3	+6	[Volt]	<table border="1"> <thead> <tr> <th>Item</th> <th>Symbol</th> <th>Min</th> <th>Max</th> <th>Unit</th> </tr> </thead> <tbody> <tr> <td>Logic/LCD Drive Voltage</td> <td>VDD</td> <td>-0.3</td> <td>+3.6</td> <td>[Volt]</td> </tr> <tr> <td>Contort Signals</td> <td>SEL68, REVERSE</td> <td>-0.3</td> <td>VDD</td> <td>[Volt]</td> </tr> <tr> <td>LVDS Signals</td> <td>CLKIN -/+, RIN0 - 3/+</td> <td>-0.3</td> <td>VDD</td> <td>[Volt]</td> </tr> <tr> <td>LED Input Voltage</td> <td>VCC</td> <td>-0.3</td> <td>+13.2</td> <td>[Volt]</td> </tr> <tr> <td>LED Control Signals</td> <td>EN, PWM</td> <td>-0.3</td> <td>+6</td> <td>[Volt]</td> </tr> </tbody> </table>	Item	Symbol	Min	Max	Unit	Logic/LCD Drive Voltage	VDD	-0.3	+3.6	[Volt]	Contort Signals	SEL68, REVERSE	-0.3	VDD	[Volt]	LVDS Signals	CLKIN -/+, RIN0 - 3/+	-0.3	VDD	[Volt]	LED Input Voltage	VCC	-0.3	+13.2	[Volt]	LED Control Signals	EN, PWM	-0.3	+6	[Volt]																																
Item	Symbol	Min	Max	Unit																																																																																											
Logic/LCD Drive Voltage	VDD	-0.3	+3.8	[Volt]																																																																																											
Contort Signals	SEL68, REVERSE	-0.3	VDD	[Volt]																																																																																											
LVDS Signals	CLKIN -/+, RIN0 - 3/+	-0.3	VDD	[Volt]																																																																																											
LED Input Voltage	VCC	-0.3	+13	[Volt]																																																																																											
LED Control Signals	EN, PWM	-0.3	+6	[Volt]																																																																																											
Item	Symbol	Min	Max	Unit																																																																																											
Logic/LCD Drive Voltage	VDD	-0.3	+3.6	[Volt]																																																																																											
Contort Signals	SEL68, REVERSE	-0.3	VDD	[Volt]																																																																																											
LVDS Signals	CLKIN -/+, RIN0 - 3/+	-0.3	VDD	[Volt]																																																																																											
LED Input Voltage	VCC	-0.3	+13.2	[Volt]																																																																																											
LED Control Signals	EN, PWM	-0.3	+6	[Volt]																																																																																											
	19	7.2 LED Backlight Unit (CN2): Driver Connector	7.2 LED Backlight Unit (CN2): Driver Connector																																																																																												
	24	10.1 Shipping Label (on the rear side of TFT-LCD display)	10.1 Shipping Label (on the rear side of TFT-LCD display)																																																																																												
0.5 2018/12/27	24																																																																																														
	1	Module: 12.1 Inch Color TFT-LCD Model Name: G121STN02 V0	Module: 12.1 Inch Color TFT-LCD Model Name: G121STN02.0																																																																																												
	17	6.5.1 Timing Characteristics	6.5.1 Timing Characteristics																																																																																												
		<table border="1"> <thead> <tr> <th>Signal</th> <th>Symbol</th> <th>Min</th> <th>Typ</th> <th>Max</th> <th>Unit</th> </tr> </thead> <tbody> <tr> <td>Clock Frequency</td> <td>1/T<sub>clock</sub></td> <td>34</td> <td>40</td> <td>48.3</td> <td>MHz</td> </tr> <tr> <td rowspan="3">Vertical Section</td> <td>Period</td> <td>T<sub>Vp</sub></td> <td>608</td> <td>628</td> <td>1023</td> <td rowspan="3">T<sub>Line</sub></td> </tr> <tr> <td>Active</td> <td>T<sub>Va</sub></td> <td>---</td> <td>600</td> <td>---</td> </tr> <tr> <td>Blanking</td> <td>T<sub>Vb</sub></td> <td>8</td> <td>28</td> <td>423</td> </tr> <tr> <td rowspan="3">Horizontal Section</td> <td>Period</td> <td>T<sub>Hp</sub></td> <td>960</td> <td>1056</td> <td>1240</td> <td rowspan="3">T<sub>clock</sub></td> </tr> <tr> <td>Active</td> <td>T<sub>Ha</sub></td> <td>---</td> <td>800</td> <td>---</td> </tr> <tr> <td>Blanking</td> <td>T<sub>Hb</sub></td> <td>160</td> <td>256</td> <td>440</td> </tr> </tbody> </table>	Signal	Symbol	Min	Typ	Max	Unit	Clock Frequency	1/T <sub>clock</sub>	34	40	48.3	MHz	Vertical Section	Period	T <sub>Vp</sub>	608	628	1023	T <sub>Line</sub>	Active	T <sub>Va</sub>	---	600	---	Blanking	T <sub>Vb</sub>	8	28	423	Horizontal Section	Period	T <sub>Hp</sub>	960	1056	1240	T <sub>clock</sub>	Active	T <sub>Ha</sub>	---	800	---	Blanking	T <sub>Hb</sub>	160	256	440	<table border="1"> <thead> <tr> <th>Signal</th> <th>Symbol</th> <th>Min</th> <th>Typ</th> <th>Max</th> <th>Unit</th> </tr> </thead> <tbody> <tr> <td>Clock Frequency</td> <td>1/T<sub>clock</sub></td> <td>34</td> <td>40</td> <td>48.3</td> <td>MHz</td> </tr> <tr> <td rowspan="3">Vertical Section</td> <td>Period</td> <td>T<sub>Vp</sub></td> <td>610</td> <td>660</td> <td>800</td> <td rowspan="3">T<sub>Line</sub></td> </tr> <tr> <td>Active</td> <td>T<sub>Va</sub></td> <td>---</td> <td>600</td> <td>---</td> </tr> <tr> <td>Blanking</td> <td>T<sub>Vb</sub></td> <td>10</td> <td>60</td> <td>200</td> </tr> <tr> <td rowspan="3">Horizontal Section</td> <td>Period</td> <td>T<sub>Hp</sub></td> <td>960</td> <td>1000</td> <td>1240</td> <td rowspan="3">T<sub>clock</sub></td> </tr> <tr> <td>Active</td> <td>T<sub>Ha</sub></td> <td>---</td> <td>800</td> <td>---</td> </tr> <tr> <td>Blanking</td> <td>T<sub>Hb</sub></td> <td>160</td> <td>200</td> <td>440</td> </tr> </tbody> </table>	Signal	Symbol	Min	Typ	Max	Unit	Clock Frequency	1/T <sub>clock</sub>	34	40	48.3	MHz	Vertical Section	Period	T <sub>Vp</sub>	610	660	800	T <sub>Line</sub>	Active	T <sub>Va</sub>	---	600	---	Blanking	T <sub>Vb</sub>	10	60	200	Horizontal Section	Period	T <sub>Hp</sub>	960	1000	1240	T <sub>clock</sub>	Active	T <sub>Ha</sub>	---	800	---	Blanking	T <sub>Hb</sub>	160	200	440
Signal	Symbol	Min	Typ	Max	Unit																																																																																										
Clock Frequency	1/T <sub>clock</sub>	34	40	48.3	MHz																																																																																										
Vertical Section	Period	T <sub>Vp</sub>	608	628	1023	T <sub>Line</sub>																																																																																									
	Active	T <sub>Va</sub>	---	600	---																																																																																										
	Blanking	T <sub>Vb</sub>	8	28	423																																																																																										
Horizontal Section	Period	T <sub>Hp</sub>	960	1056	1240	T <sub>clock</sub>																																																																																									
	Active	T <sub>Ha</sub>	---	800	---																																																																																										
	Blanking	T <sub>Hb</sub>	160	256	440																																																																																										
Signal	Symbol	Min	Typ	Max	Unit																																																																																										
Clock Frequency	1/T <sub>clock</sub>	34	40	48.3	MHz																																																																																										
Vertical Section	Period	T <sub>Vp</sub>	610	660	800	T <sub>Line</sub>																																																																																									
	Active	T <sub>Va</sub>	---	600	---																																																																																										
	Blanking	T <sub>Vb</sub>	10	60	200																																																																																										
Horizontal Section	Period	T <sub>Hp</sub>	960	1000	1240	T <sub>clock</sub>																																																																																									
	Active	T <sub>Ha</sub>	---	800	---																																																																																										
	Blanking	T <sub>Hb</sub>	160	200	440																																																																																										



AUO Confidential  
For PROMATE Internal Use Only  
2019/10/29 08:46:06

AUO Confidential  
For PROMATE Internal Use Only  
2019/10/29 08:46:06

AUO Confidential  
For PROMATE Internal Use Only  
2019/10/29 08:46:06

AUO Confidential  
For PROMATE Internal Use Only  
2019/10/29 08:46:06

## 1. Operating Precautions

- 1) Since front polarizer is easily damaged, please be cautious and not to scratch it.
- 2) Be sure to turn off power supply when inserting or disconnecting from input connector.
- 3) Wipe off water drop immediately. Long contact with water may cause discoloration or spots.
- 4) When the panel surface is soiled, wipe it with absorbent cotton or soft cloth.
- 5) Since the panel is made of glass, it may be broken or cracked if dropped or bumped on hard surface.
- 6) To avoid ESD (Electro Static Discharge) damage, be sure to ground yourself before handling TFT-LCD Module.
- 7) Do not open nor modify the module assembly.
- 8) Do not press the reflector sheet at the back of the module to any direction.
- 9) In case if a module has to be put back into the packing container slot after it was taken out from the container, do not press the center of the LED light bar edge. Instead, press at the far ends of the LED light bar edge softly. Otherwise the TFT Module may be damaged.
- 10) At the insertion or removal of the Signal Interface Connector, be sure not to rotate nor tilt the Interface Connector of the TFT Module.
- 11) TFT-LCD Module is not allowed to be twisted & bent even force is added on module in a very short time. Please design your display product well to avoid external force applying to module by end-user directly.
- 12) Small amount of materials without flammability grade are used in the TFT-LCD module. The TFT-LCD module should be supplied by power complied with requirements of Limited Power Source (IEC60950 or UL1950), or be applied exemption.
- 13) Severe temperature condition may result in different luminance, response time and lamp ignition voltage.
- 14) Continuous operating TFT-LCD display under low temperature environment may accelerate lamp exhaustion and reduce luminance dramatically.
- 15) The data on this specification sheet is applicable when LCD module is placed in landscape position.
- 16) Continuous displaying fixed pattern may induce image sticking. It's recommended to use screen saver or shuffle content periodically if fixed pattern is displayed on the screen.

## 2. General Description

This specification applies to the Color Active Matrix Liquid Crystal Display G121STN02.0 composed of a TFT-LCD display, a driver and power supply circuit, and a LED backlight system.

The screen format is intended to support SVGA (800(H) x 600(V)) screen and 16.7M (8-bits) or 262k colors (6-bits).

LED driving board for backlight unit is included in G121STN02.0

G121STN02.0 designed with wide viewing angle; wide temperature and long life LED backlight is well suited for industrial applications.

G121STN02.0 is a RoHS product.

### 2.1 Display Characteristics

The following items are characteristics summary on the table under 25 °C condition:

Items	Unit	Specifications
Screen Diagonal	[inch]	12.1
Active Area	[mm]	246 (H) x 184.5 (V)
Pixels H x V		800 x 3(RGB) x 600
Pixel Pitch	[mm]	0.3075 x 0.3075
Pixel Arrangement		R.G.B. Vertical Stripe
Display Mode		TN, Normally White
Nominal Input Voltage VDD	[Volt]	3.3 (typ.)
Typical Power Consumption	[Watt]	4.62 (Typ.) All black pattern
Weight	[Grams]	600 (max)
Physical Size	[mm]	260.5(H) x 203.0(V) x 9.0(D) (Typ.)
Electrical Interface		1 channel LVDS
Surface Treatment		Anti-glare, Hardness 3H
Support Color		16.7M / 262K colors
Temperature Range		
Operating	[°C]	-30 to +85
Storage (Non-Operating)	[°C]	-30 to +85
RoHS Compliance		RoHS Compliance



## 2.2 Optical Characteristics

The optical characteristics are measured under stable conditions at 25°C (Room Temperature):

Item	Unit	Conditions	Min.	Typ.	Max.	Remark
White Luminance	[cd/m <sup>2</sup> ]	I <sub>F</sub> = 45mA/1 LED Line (center point)	400	500	-	Note 1
Uniformity	%	5 Points	75	-	-	Note 2, 3
Contrast Ratio			600	800	-	Note 4
Response Time	[msec]	Rising	-	25	35	Note 5
	[msec]	Falling	-	10	20	
	[msec]	Raising + Falling	-	35	55	
Viewing Angle	[degree]	Horizontal (Right) CR = 10 (Left)	70	80	-	Note 6
	[degree]		70	80	-	
	[degree]	Vertical (Upper) CR = 10 (Lower)	55	65	-	
	[degree]		65	75	-	
Color / Chromaticity Coordinates (CIE 1931)		Red x	0.54	0.590	0.64	
		Red y	0.289	0.339	0.389	
		Green x	0.282	0.332	0.382	
		Green y	0.551	0.601	0.651	
		Blue x	0.11	0.160	0.21	
		Blue y	0.082	0.132	0.182	
		White x	0.263	0.313	0.363	
		White y	0.279	0.329	0.379	
Color Gamut	%			55	-	

Note 1: Measurement method

Equipment Pattern Generator, Power Supply, Digital Voltmeter, Luminance meter (SR\_3 or equivalent)

Aperture 1° with 50cm viewing distance

Test Point Center

Environment < 1 lux

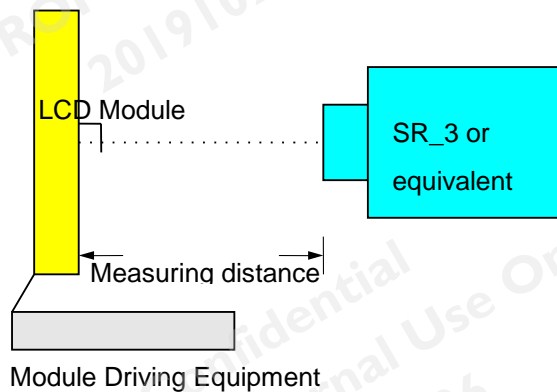

Note 2: Definition of 5 points position (Display active area: 246mm (H) x 184.5mm (V))

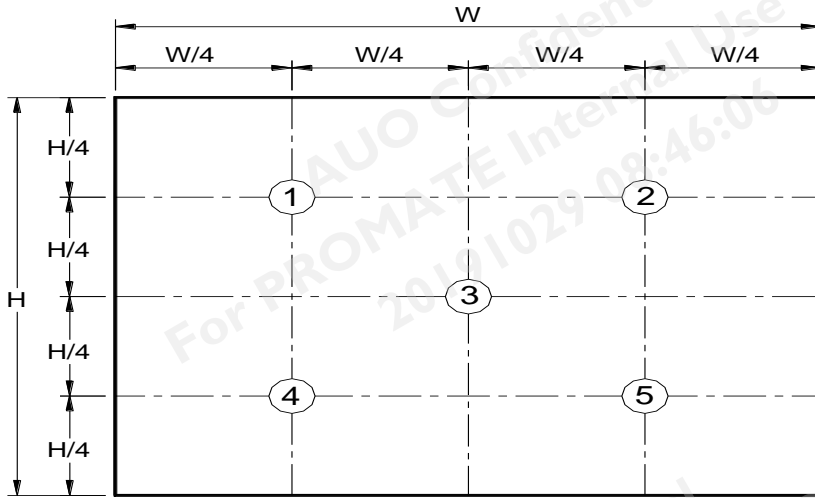

Note 3: The luminance uniformity of 5 points is defined by dividing the minimum luminance values by the maximum test point luminance

$$\delta_{w5} = \frac{\text{Minimum Brightness of five points}}{\text{Maximum Brightness of five points}}$$

Note 4: Definition of contrast ratio (CR):

$$\text{Contrast ratio (CR)} = \frac{\text{Brightness on the "White" state}}{\text{Brightness on the "Black" state}}$$

Note 5: Definition of response time:

The output signals of photo detector are measured when the input signals are changed from "White" to "Black" (falling time) and from "Black" to "White" (rising time), respectively. The response time interval is between 10% and 90% of amplitudes. Please refer to the figure as below.

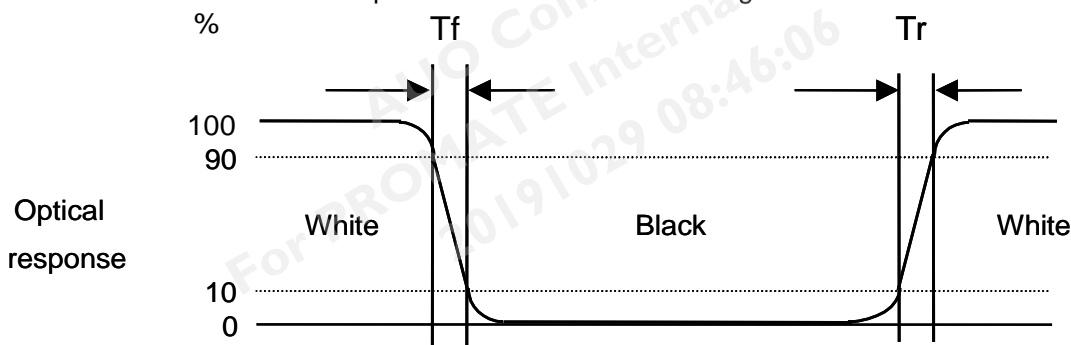

Note 6: Definition of viewing angle

Viewing angle is the measurement of contrast ratio  $\geq 10$ , at the screen center, over a 180° horizontal and 180° vertical range (off-normal viewing angles). The 180° viewing angle range is broken down as below: 90° ( $\theta$ ) horizontal left and right, and 90° ( $\Phi$ ) vertical high (up) and low (down). The measurement direction is typically perpendicular to the display surface with the screen rotated to its center to develop the desired



measurement viewing angle.

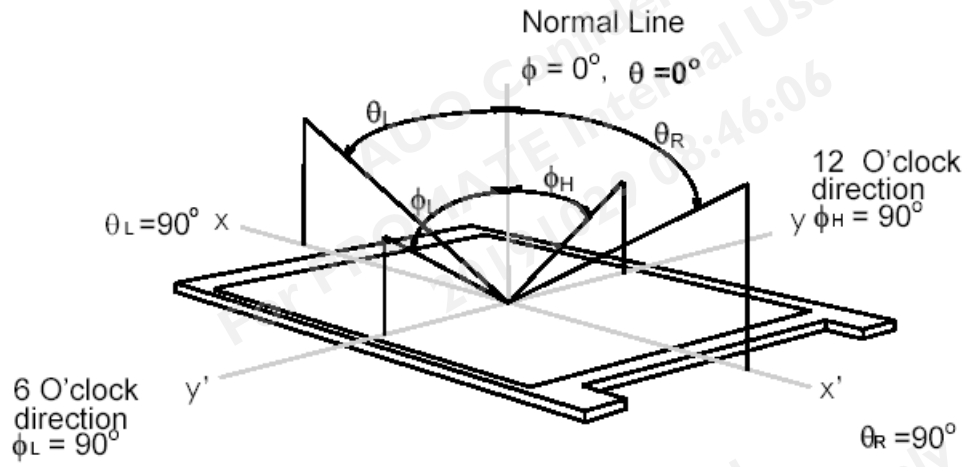

### 3. Functional Block Diagram

The following diagram shows the functional block of the 12.1 inch color TFT/LCD module:

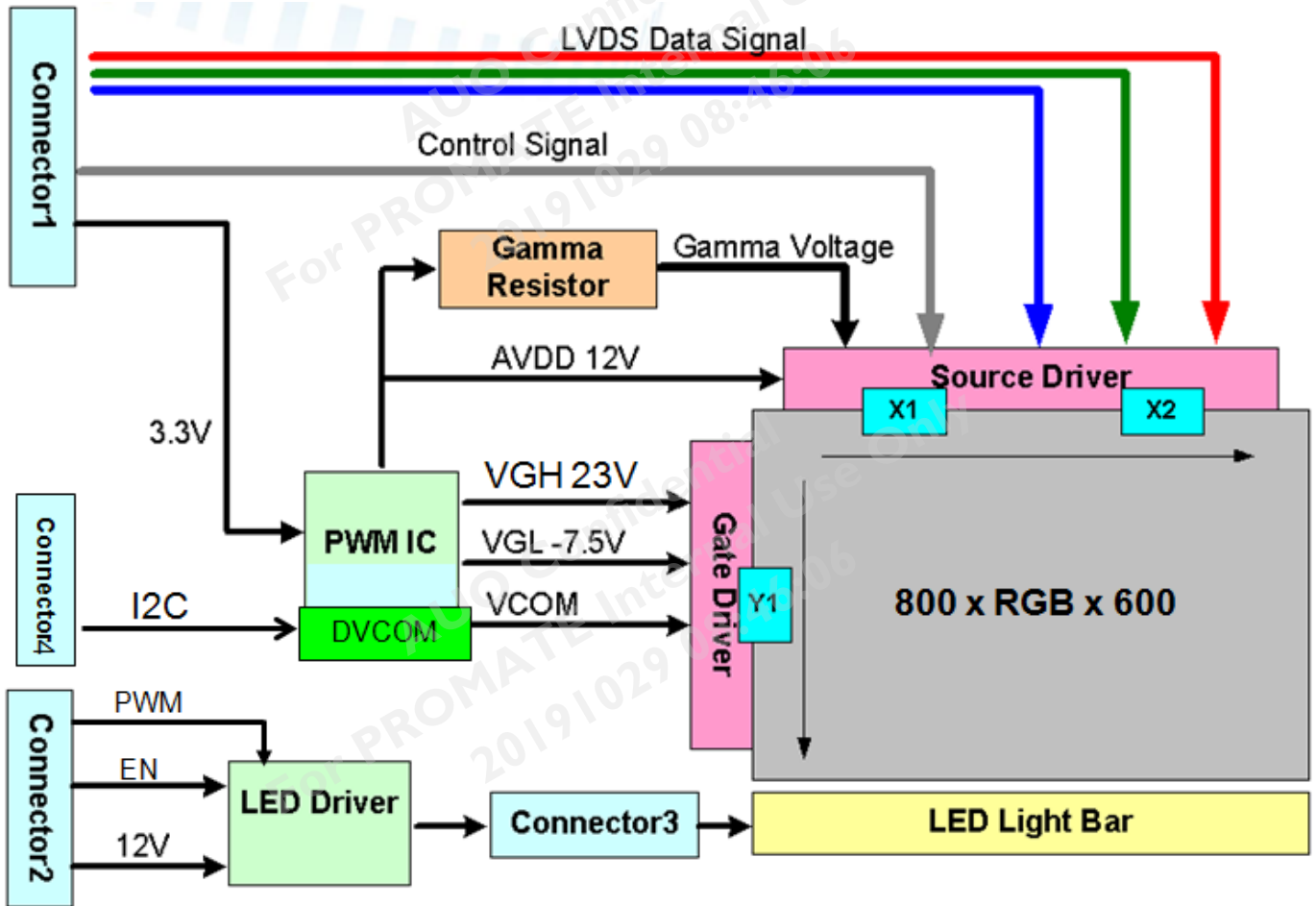

## 4. Absolute Maximum Ratings

### 4.1 Absolute Ratings of TFT LCD Module

Item	Symbol	Min	Max	Unit
Logic/LCD Drive Voltage	VDD	-0.3	+3.6	[Volt]
Control Signals	SEL68, REVERSE	-0.3	VDD	[Volt]
LVDS Signals	CLKIN -/+, RIN0 ~ 3-/+	-0.3	VDD	[Volt]
LED Input Voltage	VCC	-0.3	+13.2	[Volt]
LED Control Signals	EN, PWM	-0.3	+6	[Volt]

### 4.2 Absolute Ratings of Environment

Item	Symbol	Min	Max	Unit
Operating Temperature	TOP	-30	+85	[°C]
Operation Humidity	HOP	5	95	[%RH]
Storage Temperature	TST	-30	+85	[°C]
Storage Humidity	HST	5	95	[%RH]

Note: Maximum Wet-Bulb should be 39°C and no condensation.

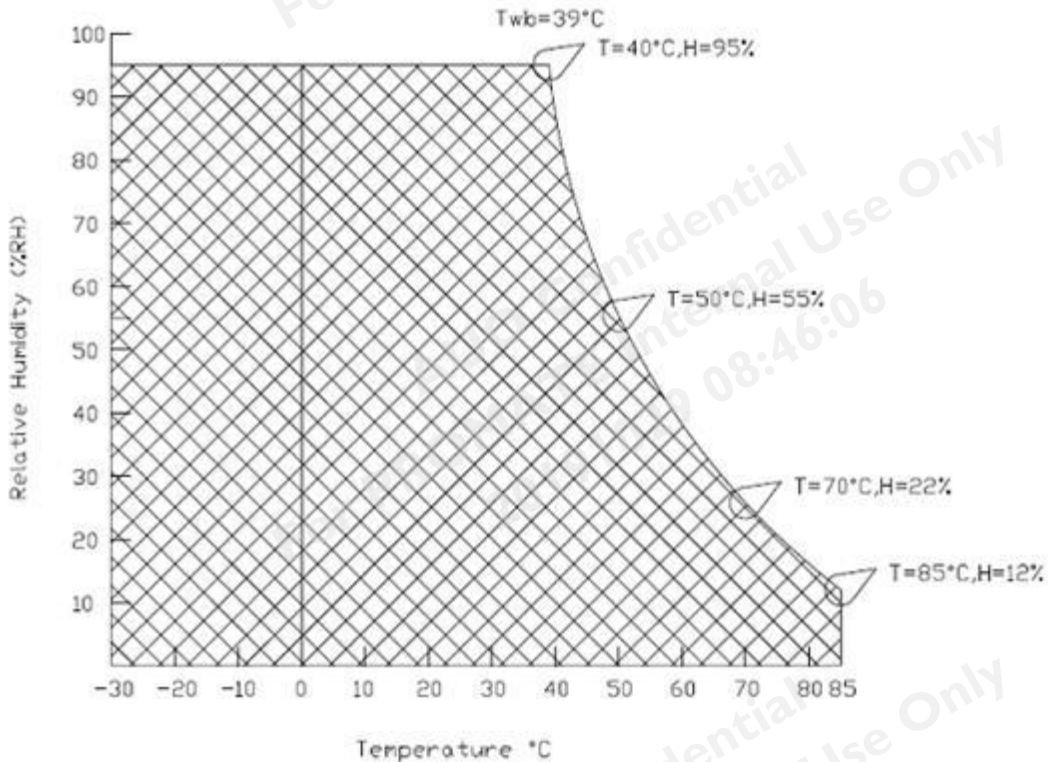

## 5. Electrical Characteristics

### 5.1 TFT LCD Module

#### 5.1.1 LCD Electrical Specification

Symbol	Parameter	Min	Typ	Max	Units	Remark	
VDD	Logic/LCD Input Voltage	3.0	3.3	3.6	[Volt]		
I <sub>VDD</sub>	LCD Input Current	-	200	240	[mA]	VDD=3.3V at 60 HZ, all Black Pattern	
P <sub>VDD</sub>	LCD Power consumption	-	660	792	[mW]	VDD=3.3V at 60 HZ, all Black Pattern	
I <sub>rush LCD</sub>	LCD Inrush Current	-	-	1.5	[A]	VDD=3.3V at 60 HZ, all Black Pattern Note 1 VDD rising time $\geq 470\mu s$	
VDD <sub>rp</sub>	Allowable Logic/LCD Drive Ripple Voltage	-	-	100	[mV] p-p	VDD=3.3V at 60 HZ, all Black Pattern	
VIH	Control Signals Voltage	High Level	0.7* VDD	-	VDD	[Volt]	SEL68 and REVERSE
VIL		Low Level	0	-	0.3* VDD	[Volt]	SEL68 and REVERSE

Note 1: Measurement condition:

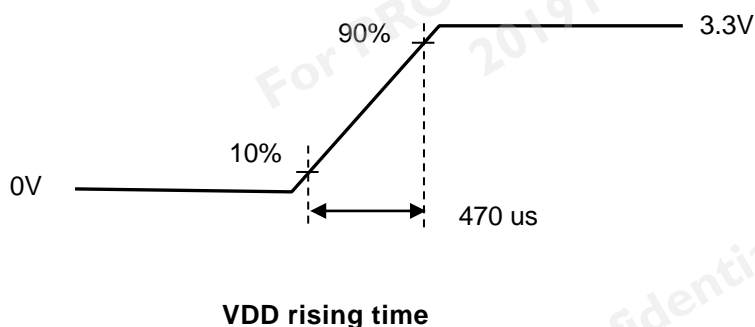

VDD rising time

### 5.1.2 LVDS Electrical Characteristics

Symbol	Parameter	Min.	Typ.	Max.	Unit	Remark
VTH	Differential Input High Threshold	-	-	100	[mV]	VCM=1.2V
VTL	Differential Input Low Threshold	-100	-	-	[mV]	VCM=1.2V
VID	Input Differential Voltage	100	400	600	[mV]	
VICM	Differential Input Common Mode Voltage	1.1	-	1.45	[V]	VTH/VTL=+-100mV

Input signals shall be low or Hi-Z state when VDD is off.

Note: LVDS Signal Waveform.

#### Single-end Signal

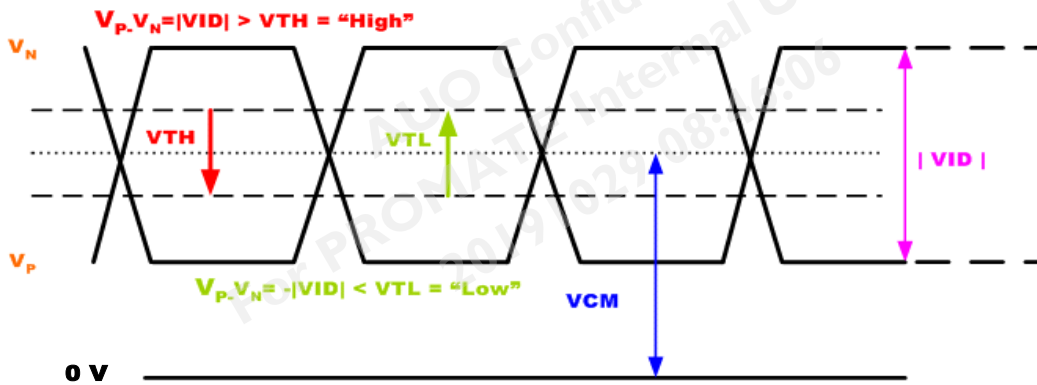

#### Differential Signal

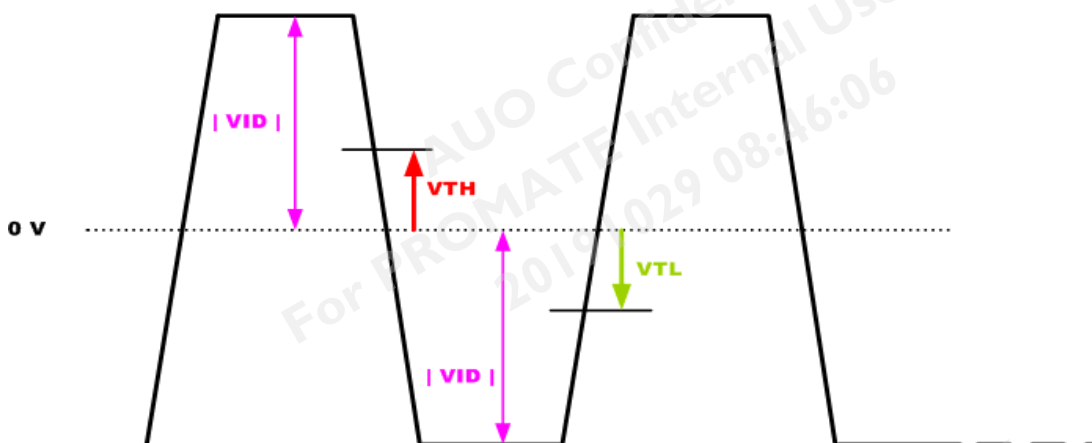

## 5.2 Backlight Unit

### 5.2.1 Parameter guideline for LCD

Following characteristics are measured under stable condition at 25°C. (Room Temperature):

Symbol	Parameter		Min.	Typ.	Max.	Unit	Remark
<b>VCC</b>	Input Voltage		10.8	12	13.2	[Volt]	
<b>I<sub>VCC</sub></b>	Input Current		-	330	350	[mA]	VCC=12V & 100% PWM Duty
<b>P<sub>VCC</sub></b>	Power Consumption		-	3960	4200	[mW]	VCC=12V & 100% PWM Duty
<b>V<sub>EN</sub></b>	EN Control Level	BL On	2.5	-	5.5	[Volt]	
		BL Off	0	-	0.5	[Volt]	
<b>F<sub>PWM</sub></b>	Dimming Frequency		200	-	20K	[Hz]	
<b>D<sub>PWM</sub></b>	Dimming Duty Cycle		5	-	100	%	
<b>V<sub>PWM</sub></b>	Dimming Control Level	High Level	2.5	-	5.5	[Volt]	
		Low Level	0	-	0.5	[Volt]	
<b>I<sub>F</sub></b>	LED Forward Current		-	42		[mA]	Ta = 25°C
<b>V<sub>F</sub></b>	LED Forward Voltage		-	3.1	3.4	[Volt]	I <sub>F</sub> = 45 mA, Ta = 25°C
<b>P<sub>LED</sub></b>	LED Power Consumption		-	3.1	3.4	[Watt]	
<b>LED life time</b>			50,000	-	-	Hrs	I <sub>F</sub> = 45 mA, Ta = 25°C

Note 1: Ta means ambient temperature of TFT-LCD module.

Note 2: VCC, I<sub>VCC</sub>, P<sub>VCC</sub> are defined for LED backlight.(100% duty of PWM dimming)

Note 3: I<sub>F</sub>, V<sub>F</sub> are defined for one piece LED. There are three LED channels in back light unit.

4 strings, 6 LEDs for each string, total 24 LEDs .

Note 4: If G121STN02 module is driven by high current or at high ambient temperature & humidity condition. The operating life will be reduced.

Note 5: Operating life means brightness goes down to 50% initial brightness. Minimum operating life time is estimated data.



## 6. Signal Characteristics

### 6.1 Pixel Format Image

Following figure shows the relationship between input signal and LCD pixel format.

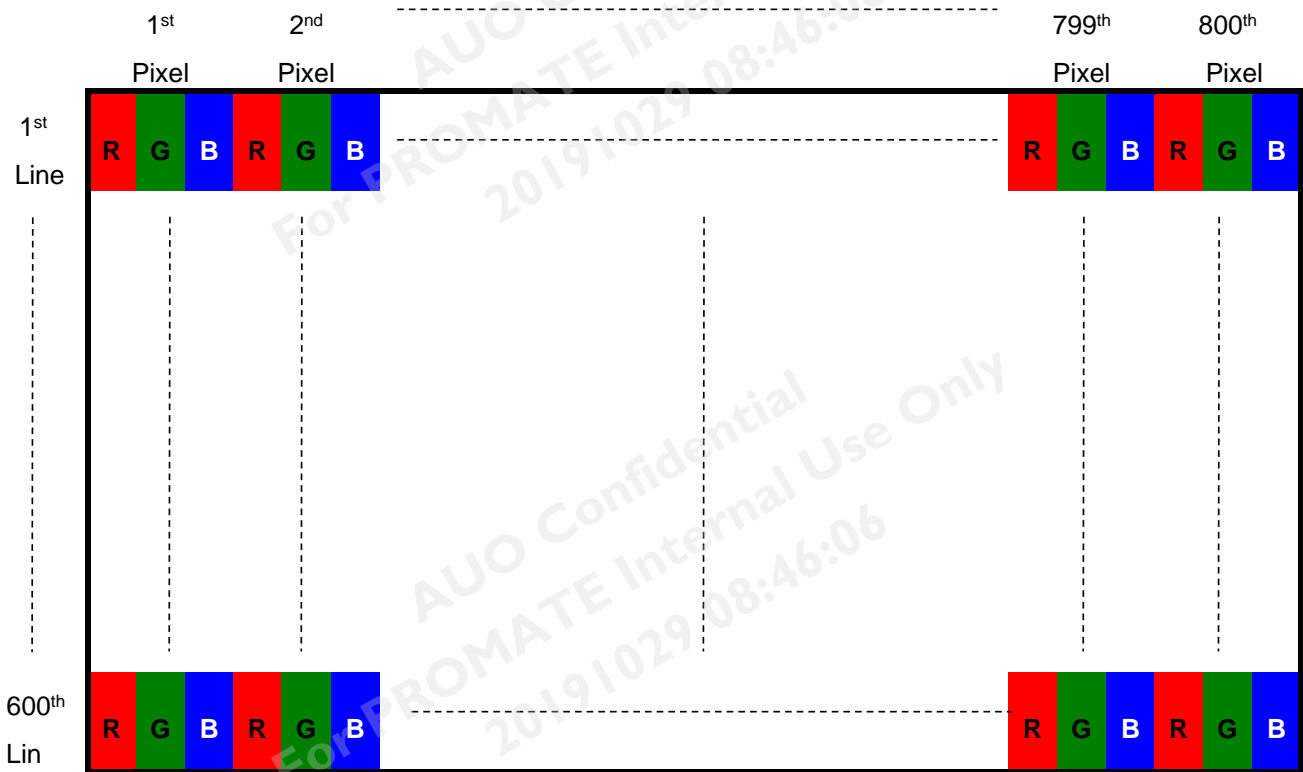

### 6.2 Scanning Direction

The following figures show the image seen from the front view. The arrow indicates the direction of scan.

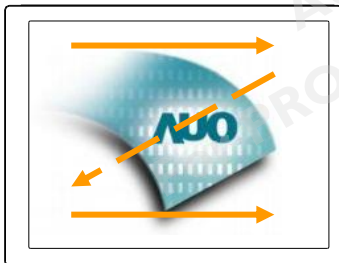

Fig. 1 Normal scan (Pin19, REVERSE = Low or NC)

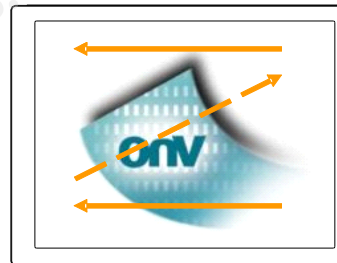

Fig. 2 Reverse scan (Pin19, REVERSE = High)

### 6.3 TFT-LCD Interface Signal Description

The module using a LVDS receiver embedded in AUO's ASIC. LVDS is a differential signal technology for LCD interface and a high-speed data transfer device.

Input Signal Interface			
Pin No.	Symbol	Description	Remark
1	VDD	Power Supply, 3.3V (typical)	
2	VDD	Power Supply, 3.3V (typical)	
3	GND	Ground	
4	SEL68	6/ 8bits LVDS data input selection [H: 8bits L/NC: 6bit]	Note1.2
5	RIN0-	LVDS receiver signal channel 0	Note1
6	RIN0+	LVDS Differential Data Input (R0, R1, R2, R3, R4, R5, G0)	
7	GND	Ground	
8	RIN1-	LVDS receiver signal channel 1	Note1
9	RIN1+	LVDS Differential Data Input (G1, G2, G3, G4, G5, B0, B1)	
10	GND	Ground	
11	RIN2-	LVDS receiver signal channel 2	Note1
12	RIN2+	LVDS Differential Data Input (B2, B3, B4, B5, HS, VS, DE)	
13	GND	Ground	
14	CLKIN-	LVDS receiver signal clock	Note1
15	CLKIN+		
16	GND	Ground	
17	RIN3-	LVDS receiver signal channel 3,	Note1
18	RIN3+	LVDS Differential Data Input (R6, R7, G6, G7, B6, B7, RSV) pin17=VDD & pin 18=GND for 6bit LVDS Input	
19	REVERSE	Reverse Scan Function [H: Enable; L/NC: Disable]	Note1.2.3
20	NC/GND	Reserved for AUO internal test. Please treat it as NC.	Note2

Note 1: Input Signals shall be in low status when VDD is off.

Note 2: High stands for "3.3V", Low stands for "0V", NC stands for "No Connection".

Note 3: There is a pull-low resistor 10Kohm on PCB, so please input "3.3V" directly for H status and "0V" directly for L status.

## 6.4 The Input Data Format

### 6.4.1 SEL68

**SEL68 = "Low" or "NC" for 6 bits LVDS Input**



**SEL68 = "High" for 8 bits LVDS Input**

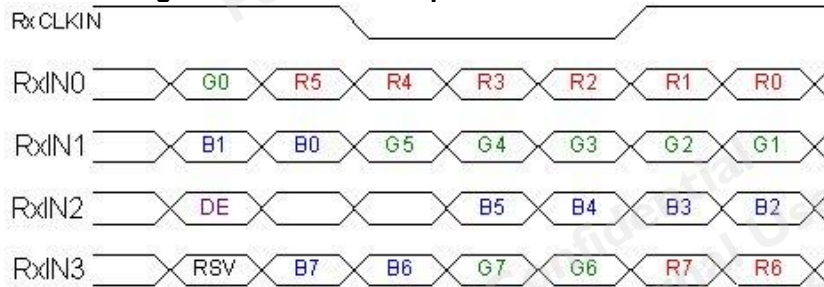

Note 1: Please follow PSWG.

Note 2: R/G/B data 7:MSB, R/G/B data 0:LSB

Note 3: RSV stands for "Reserved".

Signal Name	Description	Remark
R7	Red Data 7	Red-pixel Data
R6	Red Data 6	
R5	Red Data 5	
R4	Red Data 4	
R3	Red Data 3	
R2	Red Data 2	
R1	Red Data 1	
R0	Red Data 0	For 8Bits LVDS input MSB: R7 ; LSB: R0
G7	Green Data 7	Green-pixel Data
G6	Green Data 6	
G5	Green Data 5	
G4	Green Data 4	
G3	Green Data 3	
G2	Green Data 2	
G1	Green Data 1	
G0	Green Data 0	For 8Bits LVDS input MSB: G7 ; LSB: G0
B7	Blue Data 7	Blue-pixel Data
B6	Blue Data 6	
B5	Blue Data 5	
B4	Blue Data 4	
B3	Blue Data 3	
B2	Blue Data 2	
B1	Blue Data 1	
B0	Blue Data 0	For 8Bits LVDS input MSB: B7 ; LSB: B0
RxCLKIN	LVDS Data Clock	For 6Bits LVDS input MSB: R5 ; LSB: R0
DE	Data Enable Signal	The typical frequency is 40MHz.
RSV	Reserved Signal	When the signal is high, the pixel data shall be valid to be displayed.
		"High" or "Low" is acceptable

Note: Output signals from any system shall be low or Hi-Z state when VDD is off.

## 6.5 TFT-LCD Interface Timing

### 6.5.1 Timing Characteristics

Signal	Symbol	Min.	Typ.	Max.	Unit
Clock Frequency	$1/T_{Clock}$	34	40	48.3	MHz
Vertical Section	Period	610	660	800	$T_{Line}$
	Active	--	600	--	
	Blanking	10	60	200	
Horizontal Section	Period	960	1000	1240	$T_{Clock}$
	Active	--	800	--	
	Blanking	160	200	440	

Note 1: Frame rate is 60 Hz.

Note 2: DE mode.

Note 3: Clock min. < Vertical\*Horizontal\* Frame Rate < Clock max.

### 6.5.2 Input Timing Diagram

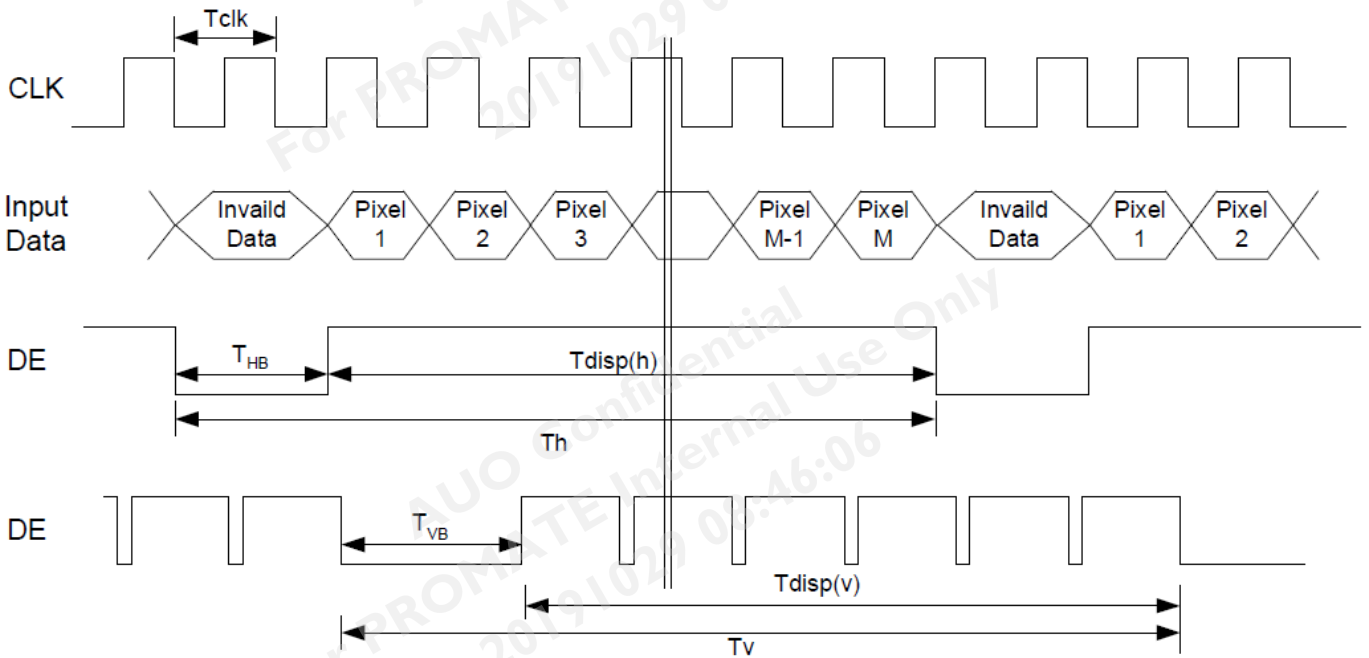

### 6.6 Power ON/OFF Sequence

VDD power and lamp on/off sequence is as below. Interface signals are also shown in the chart. Signals from any system shall be Hi-Z state or low level when VDD is off.

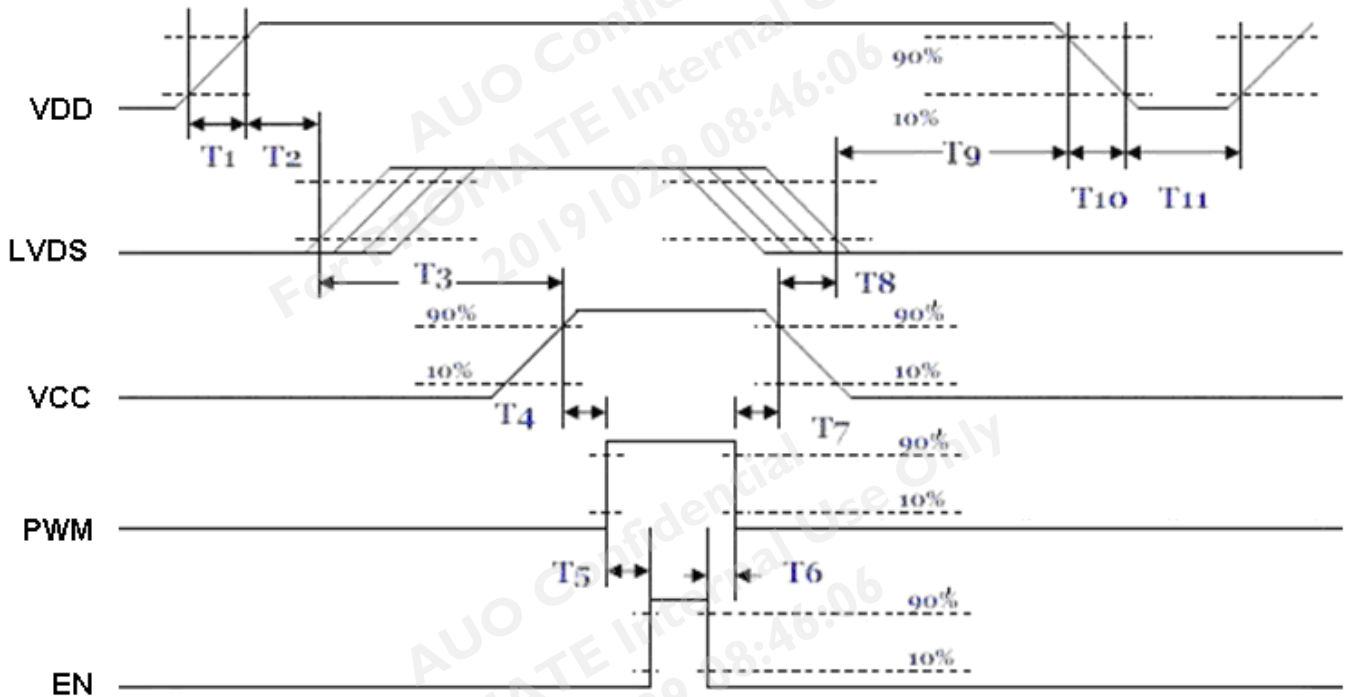

**Power ON/OFF sequence timing**

Parameter	Value			Units
	Min.	Typ.	Max.	
T1	0.5	-	10	[ms]
T2	30	40	50	[ms]
T3	175	-	-	[ms]
T4	10	-	-	[ms]
T5	10	-	-	[ms]
T6	0	-	-	[ms]
T7	10	-	-	[ms]
T8	100	-	-	[ms]
T9	0	16	50	[ms]
T10	-	-	10	[ms]
T11	1000	-	-	[ms]

The above on/off sequence should be applied to avoid abnormal function in the display. Please make sure to turn off the power when you plug the cable into the input connector or pull the cable out of the connector.

## 7. Connector & Pin Assignment

Physical interface is described as for the connector on module. These connectors are capable of accommodating the following signals and will be following components.

### 7.1 TFT-LCD Signal (CN1): LCD Connector

Connector Name / Designation	Signal Connector
Manufacturer	STM or compatible
Connector Model Number	MSB240420HE or compatible
Adaptable Plug	P240420 or compatible

Pin No.	Symbol	Pin No.	Symbol
1	VDD	2	VDD
3	GND	4	SEL68
5	RIN0-	6	RIN0+
7	GND	8	RIN1-
9	RIN1+	10	GND
11	RIN2-	12	RIN2+
13	GND	14	CLKIN-
15	CLKIN+	16	GND
17	RIN3-	18	RIN3+
19	REVERSE	20	NC/GND

### 7.2 LED Backlight Unit (CN2): Driver Connector

Connector Name / Designation	Lamp Connector
Manufacturer	ENTERY or compatible
Connector Model Number	3808K-F05N-12R or compatible
Mating Model Number	H208K-D05N-22B or compatible

Pin No.	symbol	description
Pin1	VCC	12V input
Pin2	GND	GND
Pin3	EN	5V-ON,0V-OFF
Pin4	PWM	Dimming
Pin5	NC	No Connection



### 7.3 LED Backlight Unit: Light bar Connector

<b>Connector Name / Designation</b>	<b>Lamp Connector</b>
Manufacturer	ENTERY or compatible
Connector Model Number	7083K-F06N-04L or compatible

Pin No.	symbol	description
Pin1	L	LED cathode
Pin2	L	LED cathode
Pin3	H	LED anode
Pin4	H	LED anode
Pin5	L	LED cathode
Pin6	L	LED cathode

AUO Confidential  
For PROMATE Internal Use Only  
2019/10/29 08:46:06

AUO Confidential  
For PROMATE Internal Use Only  
2019/10/29 08:46:06

AUO Confidential  
For PROMATE Internal Use Only  
2019/10/29 08:46:06

## 8. Reliability Test Criteria

Items	Required Condition	Note
Temperature Humidity Bias	40 °C, 90%RH, 300 hours	
High Temperature Operation	85 °C, 300 hours	
Low Temperature Operation	-30 °C, 300 hours	
Hot Storage	85 °C, 300 hours	
Cold Storage	-30 °C, 300 hours	
Thermal Shock Test	-20 °C / 30 min, 60 °C / 30 min, 100cycles, 40 °C minimum ramp rate	
Hot Start Test	85 °C / 1Hr min. power on/off per 5 minutes, 5 times	
Cold Start Test	-30 °C / 1Hr min. power on/off per 5 minutes, 5 times	
Shock Test (Non-Operating)	50G, 20ms, Half-sine wave, ( ±X, ±Y, ±Z)	
Vibration Test (Non-Operating)	1.5G, (10~200Hz, Sine wave) 30 mins/axis, 3 direction (X, Y, Z)	
On/off test	On/10 sec, Off/10 sec, 30,000 cycles	
ESD	Contact Discharge: ± 8KV, 150pF(330Ω ) 1sec, 8 points, 25 times/ point Air Discharge: ± 15KV, 150pF(330Ω ) 1sec, 8 points, 25 times/ point	Note 1
EMI	30-230 MHz, limit 40 dBu V/m, 230-1000 MHz, limit 47 dBu V/m	

Note1: According to EN61000-4-2, ESD class B: Some performance degradation allowed. No data lost  
Self-recoverable. No hardware failures.

Note2:

- Water condensation is not allowed for each test items.
- Each test is done by new TFT-LCD module. Don't use the same TFT-LCD module repeatedly for reliability test.
- The reliability test is performed only to examine the TFT-LCD module capability.
- To inspect TFT-LCD module after reliability test, please store it at room temperature and room humidity for 24 hours at least in advance.

## 9. Mechanical Characteristics

### 9.1 LCM Outline Dimension (Front View)

NOTE: Tolerance unless marked are  $\pm 0.5\text{mm}$

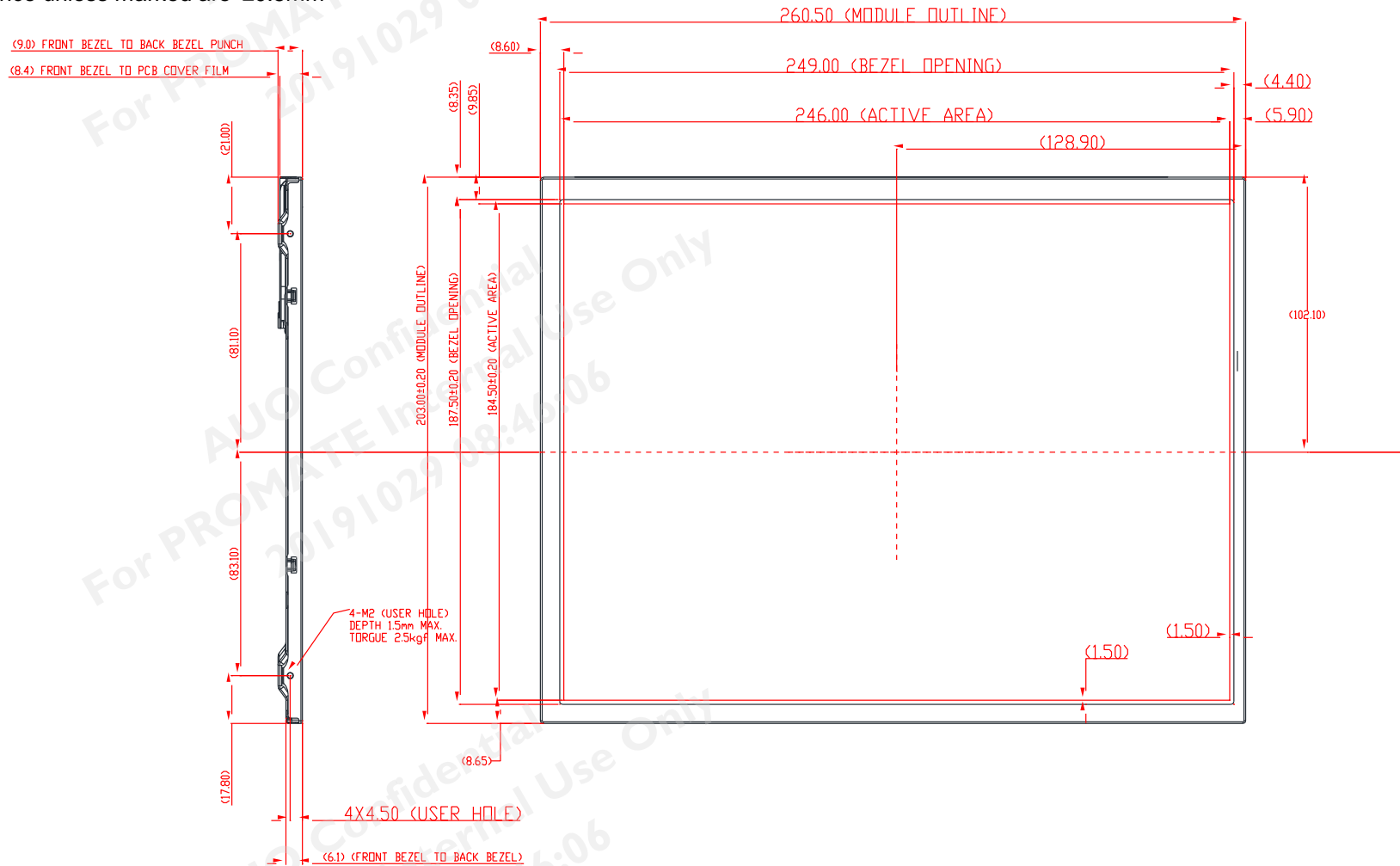

## 9.2 LCM Outline Dimension (Rear View)

NOTE: Tolerance unless marked are  $\pm 0.5\text{mm}$

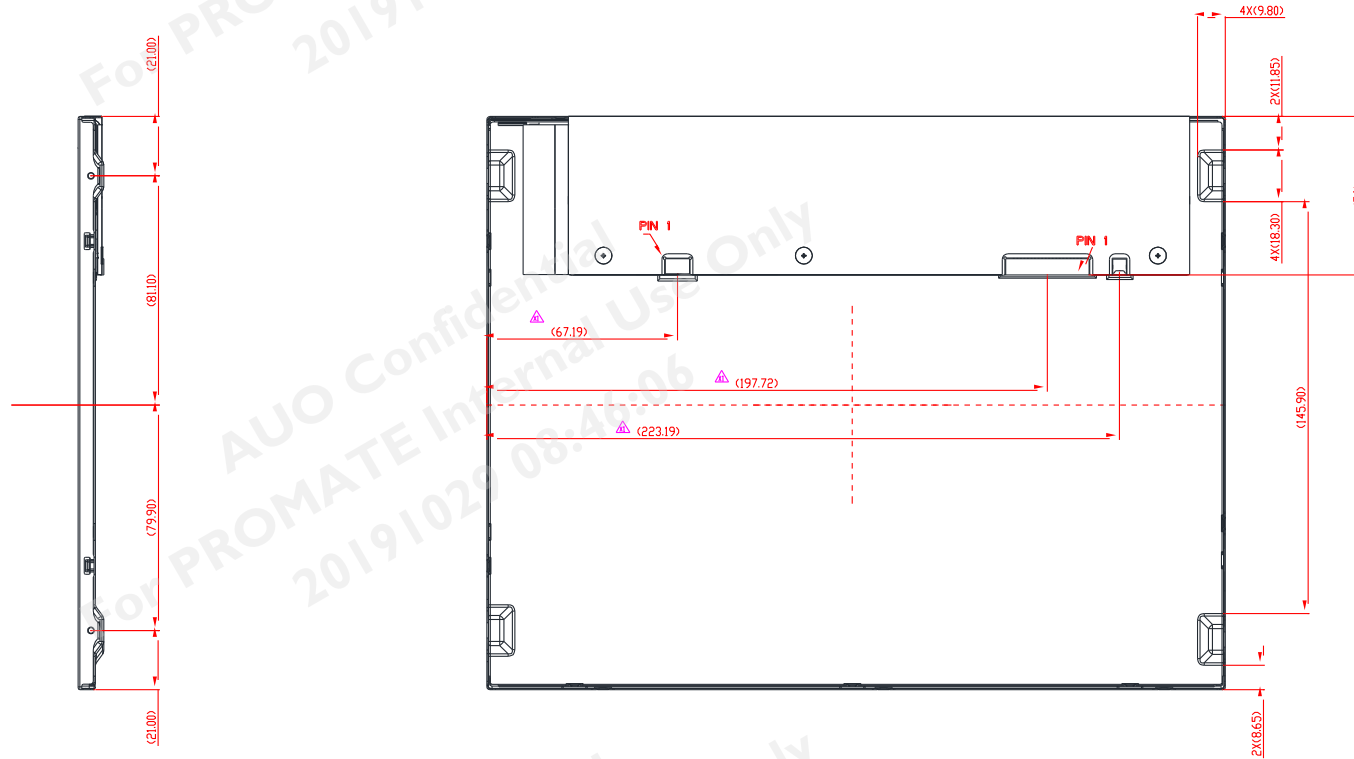

## 10. Label and Packaging

### 10.1 Shipping Label (on the rear side of TFT-LCD display)

Label Size: 90\*23(mm)

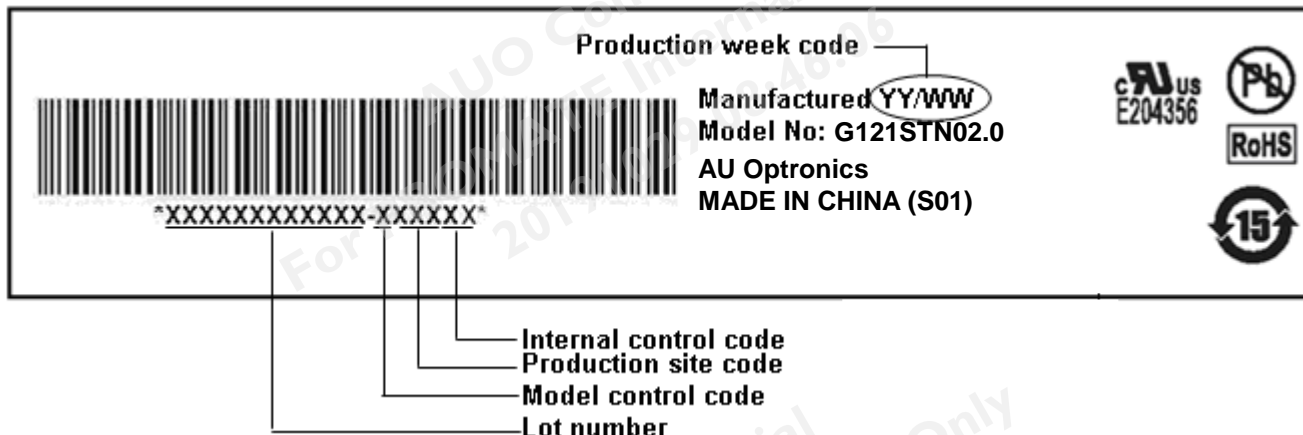

### 10.2 Carton Package

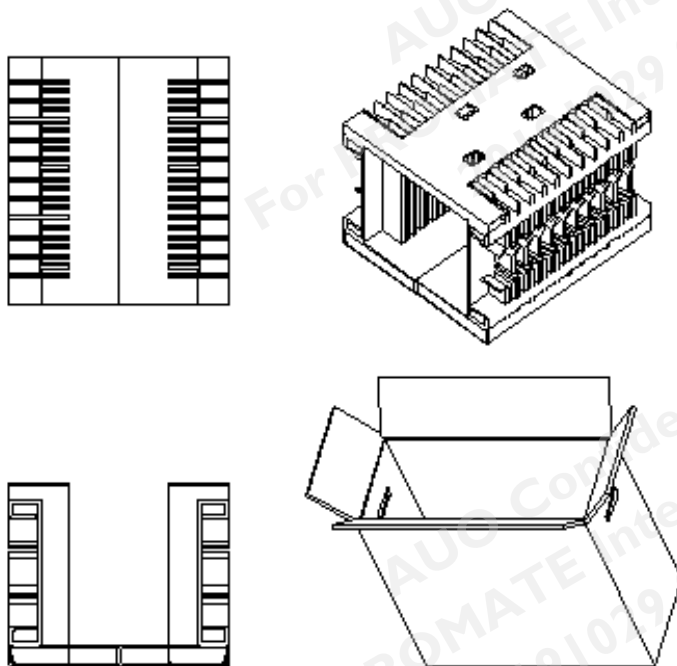

Note:

1. Max. Capacity: 20pcs LCD Modules / per carton
2. Max. Weight: 15.0 kg / per carton
3. The outside dimension of carton is 570(L) mm x 320(W) mm x 420(H) mm
4. Pallet : 1150mm\*980mm\*135mm (M17)

## 11 Safety

### 11.1 Sharp Edge Requirements

There will be no sharp edges or corners on the display assembly that could cause injury.

### 11.2 Materials

#### 11.2.1 Toxicity

There will be no carcinogenic materials used anywhere in the display module. If toxic materials are used, they will be reviewed and approved by the responsible AUO toxicologist.

#### 11.2.2 Flammability

All components including electrical components that do not meet the flammability grade UL94-V1 in the module will complete the flammability rating exception approval process.

The printed circuit board will be made from material rated 94-V1 or better. The actual UL flammability rating will be printed on the printed circuit board.

### 11.3 Capacitors

If any polarized capacitors are used in the display assembly, provisions will be made to keep them from being inserted backwards.

### 11.4 National Test Lab Requirement

The display module will satisfy all requirements for compliance to:

**UL 1950, First Edition**

U.S.A. Information Technology Equipment