

## AFI TYPE AC - up to 63 A

Page 5-2



- Module width: 2M, 4M
- Rated current  $I_n$ : 25, 40, 63 A
- Rated residual current  $I_{\Delta n}$ : 30, 100, 300 mA

## NFI TYPE A - up to 100 A

Page 5-5



- Module width: 2M, 4M
- Rated current  $I_n$ : 16, 25, 40, 63, 80, 100 A
- Rated residual current  $I_{\Delta n}$ : 10, 30, 100, 300, 500 mA
- VDE, EAC

## NFI TYPE F - up to 100 A

Page 5-10



- Module width: 2M, 4M
- Rated current  $I_n$ : 16, 25, 40, 63, 80, 100 A
- Rated residual current  $I_{\Delta n}$ : 10, 30, 100, 300, 500 mA
- VDE, EAC

## NFI TYPE B - up to 80 A

Page 5-14



- Module width: 4M
- Rated current  $I_n$ : 25, 40, 63, 80 A
- Rated residual current  $I_{\Delta n}$ : 30, 100, 300, 500 mA
- VDE, EAC

## FI TYPE A - up to 125 A

Page 5-18



- Module width: 2M, 4M
- Rated current  $I_n$ : 16, 25, 40, 63, 80, 100, 125 A
- Rated residual current  $I_{\Delta n}$ : 10, 30, 100, 300, 500 mA

## FI TYPE F - up to 125 A

Page 5-25



- Module width: 2M, 4M
- Rated current  $I_n$ : 16, 25, 40, 63, 80, 100, 125 A
- Rated residual current  $I_{\Delta n}$ : 30, 100, 300, 500 mA

## FI TYPE B - up to 125 A

Page 5-30



- Module width: 2M, 4M
- Rated current  $I_n$ : 25, 40, 63, 80, 100, 125 A
- Rated residual current  $I_{\Delta n}$ : 30, 100, 300, 500 mA

WITH A RESIDUAL CURRENT CIRCUIT BREAKER (RCCB) THE FOLLOWING PROTECTIVE MEASURES ARE AVAILABLE: FAULT PROTECTION, PROTECTION AGAINST FIRE AND ADDITIONAL PROTECTION IN CASE OF DIRECT CONTACT. THEY ARE ALSO SUITABLE FOR ISOLATION AND HAVE OPTIONAL OPERATION POSITION.

# RESIDUAL CURRENT CIRCUIT BREAKERS - TYPE AC

AFI



RESIDUAL CURRENT CIRCUIT BREAKERS AFI ARE SWITCHES WITH INSTANTANEOUS TRIPPING. THEY ARE USED FOR PROTECTION AGAINST INDIRECT CONTACT, FIRE PROTECTION AND ADDITIONAL PROTECTION AGAINST DIRECT CONTACT. AFI TYPE AC IS SENSITIVE TO RESIDUAL SINUSOIDAL ALTERNATING CURRENTS ONLY.

5

## FEATURES

- They are suitable for isolation (switch disconnector)
- Degree of protection IP20; after installation in a distribution box IP40
- Assembly to a 35 mm wide mounting rail in accordance with EN 60715
- Additional colour display of the main contact position (red - contacts closed, green - contacts open)

## ORDERING DATA

Residual current circuit breakers up to 63 A .....	page 5-2
Connections .....	page 5-5
Example - Ordering data .....	page 5-3
Technical characteristics .....	page 5-4
Dimensions .....	page 5-5

# RESIDUAL CURRENT CIRCUIT BREAKERS - AFI

## TYPE AC - SENSITIVE TO AC RESIDUAL CURRENTS

AFI2 - type AC, without time delay

Type	Rated current $I_n$ (A)	Rated residual current $I_{\Delta n}$ (A)	Number of poles	Ordering No.	Weight (g)	Packaging (pcs)
AFI2 25/0.03	25	0.03	2	30.105.058	215	1
AFI2 25/0.3	25	0.3	2	30.105.059	215	1
AFI2 25/0.5	25	0.5	2	30.105.060	215	1
AFI2 40/0.03	40	0.03	2	30.105.061	215	1
AFI2 40/0.3	40	0.3	2	30.105.062	215	1
AFI2 63/0.03	63	0.03	2	30.105.063	215	1
AFI2 63/0.3	63	0.3	2	30.105.064	215	1



5

AFI4 - type AC, without time delay

Type	Rated current $I_n$ (A)	Rated residual current $I_{\Delta n}$ (A)	Number of poles	Ordering No.	Weight (g)	Packaging (pcs)
AFI4 25/0.03	25	0.03	4	30.105.067	360	1
AFI4 25/0.3	25	0.3	4	30.105.068	360	1
AFI4 25/0.5	25	0.5	4	30.105.069	360	1
AFI4 40/0.03	40	0.03	4	30.105.070	360	1
AFI4 40/0.3	40	0.3	4	30.105.071	360	1
AFI4 40/0.5	40	0.5	4	30.105.072	360	1
AFI4 63/0.03	63	0.03	4	30.105.073	360	1
AFI4 63/0.3	63	0.3	4	30.105.074	360	1
AFI4 63/0.5	63	0.5	4	30.105.075	360	1



## ORDERING DATA

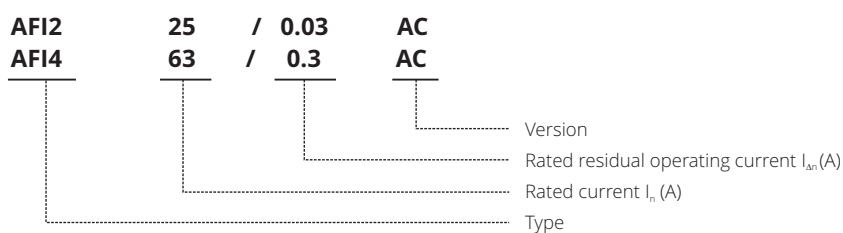

ORDERING DATA

# RESIDUAL CURRENT CIRCUIT BREAKERS -AFI

Type	AC	Symbol	Unit	AFI2	AFI4
Standards				IEC/EN 61008	
Approvals				CE	
Module width				2	4
Number of poles				2	4
Rated voltage		$U_n$	V	230	400
Rated insulation voltage		$U_i$	V	400	
Rated impulse withstand voltage		$U_{imp}$	kV	4	
Rated frequency		f	Hz	50	
Rated current		$I_n$	A	25, 40, 63	
Rated residual current		$I_{\Delta n}$	mA	30, 300, 500	
Residual operating current (AC 50 Hz)				0.5 - 1.0 $I_{\Delta n}$	
Rated conditional short-circuit current		$I_{nc}$	kA	6	
Rated making and breaking capacity		$I_m$	A	630 ( $I_n = 25 - 63$ A)	
Rated residual making and breaking capacity		$I_{\Delta m}$	A	63	
Max. back-up fuse for short-circuit current $g_L$		$I_v$	A	63	
Maximum breaking times				1 x $I_{\Delta n}$ : < 300 ms; 5 x $I_{\Delta n}$ : < 40 ms	
Minimum response time delay				instantaneous	
Mechanical endurance			op. c.	min. 5000	
Electrical endurance			op. c.	min. 2000	
Minimum distance of open contacts			mm	4	
Ambient temperature			°C	-25 ... +40	
Storage temperature			°C	-35 ... +60	
Resistance to climate				acc. to IEC 60068-2-30: 28 cycles (55 °C, 95 % relative humidity)	
Terminal capacity					
rigid (solid or stranded)		S	mm <sup>2</sup>	1 ... 35	
flexible				1 ... 35	
Screw				M5	
Screw head				PZ2	
Tightening torque			Nm	2.0	
Length of removed conductor insulation			mm	15	
Degree of protection				IP20 (IP40 after installation in a distribution box)	
Pollution degree				2	
Weight			g	215	360

5

TECHNICAL DATA

# RESIDUAL CURRENT CIRCUIT BREAKERS - AFI

AFI2

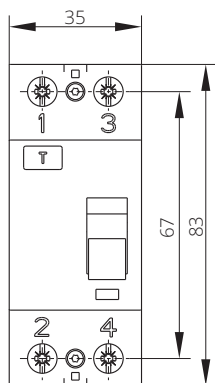

AFI4

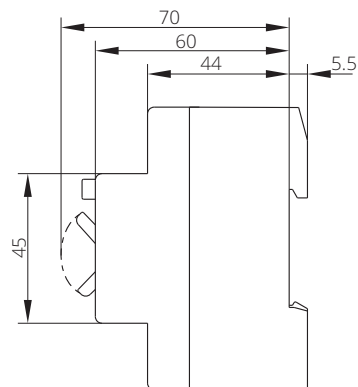
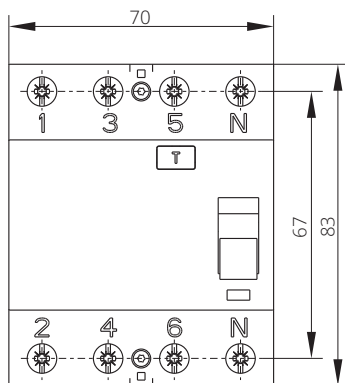

5

## Schematics

AFI2

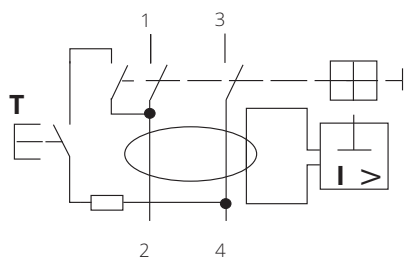

AFI4

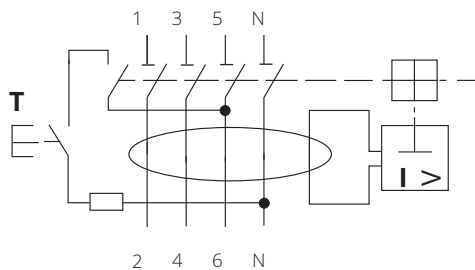

DIMENSIONS

# RESIDUAL CURRENT CIRCUIT BREAKERS - TYPE A, TYPE F

NFI, NFIK, NFIS, NFIF



RESIDUAL CURRENT CIRCUIT BREAKERS (RCCB) ARE USED FOR PROTECTION AGAINST INDIRECT CONTACT, FIRE PROTECTION AND ADDITIONAL PROTECTION AGAINST DIRECT CONTACT. THEY ARE SENSITIVE TO ALTERNATING AND PULSATING DIRECT RESIDUAL CURRENTS.



5

## FEATURES

- They are suitable for isolation.
- No overload protection or short-circuit protection is built in RCCB.
- Assembly to a 35 mm wide mounting rail in accordance with EN 60715
- Optional operation position
- Degree of protection IP20, degree of protection IP40 after installation in a distribution box
- Additional colour display of the position of main contacts (red - contacts closed, green - contacts open)
- A terminal shape prevents connection of a conductor outside the connection area.

## SPECIAL VERSIONS

### • NFIK - SENSITIVE TO AC AND PULSATING DIRECT RESIDUAL CURRENTS

- Short-time delayed RCCBs with minimum non-actuating time 10 ms (type G acc. to ÖVE E 8601)
- Surge current withstand capability with current waveform 8/20  $\mu$ s up to 3 kA
- High immunity against unwanted tripping at current impulses (e.g. a high number of fluorescent lamps, transient effects) or when installed in special critical conditions (leakage currents of impulse shape at long cables, the influence of storms, computers, X-ray devices, etc.).

### • NFIS - SENSITIVE TO AC AND PULSATING DIRECT RESIDUAL CURRENTS

- Time delayed selective type with minimum non-actuating time 40 ms (type S)
- Surge current withstand capability with current waveform 8/20  $\mu$ s up to 3 kA
- Selectivity regarding a general type and a short-time delayed type is enabled
- Particularly suitable as the main RCCB

### • NFIF - SENSITIVE TO RESIDUAL CURRENTS AS TYPE A AND IN ADDITION TO RESIDUAL CURRENTS WITH MIXED FREQUENCIES

- Sensitive to residual currents as type A and in addition to residual currents with mixed frequencies up to 1 kHz that can result from single-phase electrical loads with frequency inverters (acc. to IEC/EN 62423)
- Surge current withstand capability with current waveform 8/20  $\mu$ s up to 3 kA
- Intended for protection when using washing machines, vacuum cleaners, dishwashers, heating pumps, lighting system ...

## ORDERING DATA

Residual current circuit breakers up to 100 A ..... page 5-6  
Connections ..... page 5-13

Example - Ordering data ..... page 5-7, 8, 9, 10  
Technical characteristics ..... page 5-11  
Dimensions ..... page 5-13

# RESIDUAL CURRENT CIRCUIT BREAKERS - NFI

## TYPE A - SENSITIVE TO AC AND PULSATING DIRECT RESIDUAL CURRENTS

NFI2 - type A, instantaneous tripping

Type	Rated current $I_n$ (A)	Rated residual current $I_{\Delta n}$ (A)	Number of poles	Ordering No.	Weight (g)	Packaging (pcs)
NFI2 16/0.01	16	0.01	2	30.104.260	184	1
NFI2 25/0.01	25	0.01	2	30.104.264	184	1
NFI2 16/0.03	16	0.03	2	30.104.238	184	1
NFI2 25/0.03	25	0.03	2	30.104.239	184	1
NFI2 40/0.03	40	0.03	2	30.104.240	184	1
NFI2 63/0.03	63	0.03	2	30.104.241	184	1
NFI2 80/0.03	80	0.03	2	30.104.357	184	1
NFI2 100/0.03	100	0.03	2	30.104.553	184	1
NFI2 16/0.1	16	0.1	2	30.104.261	184	1
NFI2 25/0.1	25	0.1	2	30.104.265	184	1
NFI2 40/0.1	40	0.1	2	30.104.268	184	1
NFI2 63/0.1	63	0.1	2	30.104.271	184	1
NFI2 80/0.1	80	0.1	2	30.104.644	184	1
NFI2 100/0.1	100	0.1	2	30.104.554	184	1
NFI2 16/0.3	16	0.3	2	30.104.262	184	1
NFI2 25/0.3	25	0.3	2	30.104.266	184	1
NFI2 40/0.3	40	0.3	2	30.104.269	184	1
NFI2 63/0.3	63	0.3	2	30.104.272	184	1
NFI2 80/0.3	80	0.3	2	30.104.450	184	1
NFI2 100/0.3	100	0.3	2	30.104.555	184	1
NFI2 16/0.5	16	0.5	2	30.104.263	184	1
NFI2 25/0.5	25	0.5	2	30.104.267	184	1
NFI2 40/0.5	40	0.5	2	30.104.270	184	1
NFI2 63/0.5	63	0.5	2	30.104.273	184	1
NFI2 80/0.5	80	0.5	2	30.104.645	184	1
NFI2 100/0.5	100	0.5	2	30.104.556	184	1



5

NFI4 - type A, instantaneous tripping

Type	Rated current $I_n$ (A)	Rated residual current $I_{\Delta n}$ (A)	Number of poles	Ordering No.	Weight (g)	Packaging (pcs)
NFI4 16/0.01	16	0.01	4	30.104.823	316	1
NFI4 25/0.01	25	0.01	4	30.104.786	316	1
NFI4 25/0.03	25	0.03	4	30.104.296	316	1
NFI4 40/0.03	40	0.03	4	30.104.300	316	1
NFI4 63/0.03	63	0.03	4	30.104.304	316	1
NFI4 80/0.03	80	0.03	4	30.104.358	316	1
NFI4 100/0.03	100	0.03	4	30.104.550	360	1
NFI4 25/0.1	25	0.1	4	30.104.297	316	1
NFI4 40/0.1	40	0.1	4	30.104.301	316	1
NFI4 63/0.1	63	0.1	4	30.104.305	316	1
NFI4 80/0.1	80	0.1	4	30.104.436	316	1
NFI4 100/0.1	100	0.1	4	30.104.551	360	1
NFI4 25/0.3	25	0.3	4	30.104.298	316	1
NFI4 40/0.3	40	0.3	4	30.104.302	316	1
NFI4 63/0.3	63	0.3	4	30.104.306	316	1
NFI4 80/0.3	80	0.3	4	30.104.433	316	1
NFI4 100/0.3	100	0.3	4	30.104.552	360	1
NFI4 25/0.5	25	0.5	4	30.104.299	316	1
NFI4 40/0.5	40	0.5	4	30.104.303	316	1
NFI4 63/0.5	63	0.5	4	30.104.307	316	1
NFI4 80/0.5	80	0.5	4	30.104.443	316	1
NFI4 100/0.5	100	0.5	4	30.104.619	360	1



**NOTE:** Rated current 32 A on request  
Rated voltage 110 V on request

## ORDERING DATA

**NFI4 25 / 0.03**

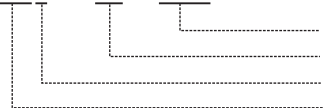

Rated residual operating current  $I_{\Delta n}$  (A)  
Rated current  $I_n$  (A)  
Number of poles  
Type

# RESIDUAL CURRENT CIRCUIT BREAKERS - NFIK

## TYPE A - SENSITIVE TO AC AND PULSATING DIRECT RESIDUAL CURRENTS

NFI2K - type A, short-time delayed **G**

Type	Rated current $I_n$ (A)	Rated residual current $I_{\Delta n}$ (A)	Number of poles	Ordering No.	Weight (g)	Packaging (pcs)
NFI2K 16/0.03	16	0.03	2	30.104.824	184	1
NFI2K 25/0.03	25	0.03	2	30.104.767	184	1
NFI2K 40/0.03	40	0.03	2	30.104.791	184	1
NFI2K 63/0.03	63	0.03	2	30.104.901	184	1
NFI2K 80/0.03	80	0.03	2	30.104.670	184	1
NFI2K 100/0.03	100	0.03	2	30.104.672	184	1
NFI2K 16/0.1	16	0.1	2	30.104.825	184	1
NFI2K 25/0.1	25	0.1	2	30.104.665	184	1
NFI2K 40/0.1	40	0.1	2	30.104.667	184	1
NFI2K 63/0.1	63	0.1	2	30.104.669	184	1
NFI2K 80/0.1	80	0.1	2	30.104.671	184	1
NFI2K 100/0.1	100	0.1	2	30.104.673	184	1
NFI2K 16/0.3	16	0.3	2	30.104.826	184	1
NFI2K 25/0.3	25	0.3	2	30.104.827	184	1
NFI2K 40/0.3	40	0.3	2	30.104.798	184	1
NFI2K 63/0.3	63	0.3	2	30.104.828	184	1
NFI2K 80/0.3	80	0.3	2	30.104.829	184	1
NFI2K 100/0.3	100	0.3	2	30.104.830	184	1
NFI2K 16/0.5	16	0.5	2	30.104.831	184	1
NFI2K 25/0.5	25	0.5	2	30.104.832	184	1
NFI2K 40/0.5	40	0.5	2	30.104.833	184	1
NFI2K 63/0.5	63	0.5	2	30.104.834	184	1
NFI2K 80/0.5	80	0.5	2	30.104.835	184	1
NFI2K 100/0.5	100	0.5	2	30.104.836	184	1



5

NFI4K - type A, short-time delayed **G**

Type	Rated current $I_n$ (A)	Rated residual current $I_{\Delta n}$ (A)	Number of poles	Ordering No.	Weight (g)	Packaging (pcs)
NFI4K 25/0.03	25	0.03	4	30.104.787	316	1
NFI4K 40/0.03	40	0.03	4	30.104.542	316	1
NFI4K 63/0.03	63	0.03	4	30.104.543	316	1
NFI4K 80/0.03	80	0.03	4	30.104.582	316	1
NFI4K 100/0.03	100	0.03	4	30.104.694	360	1
NFI4K 25/0.1	25	0.1	4	30.104.687	316	1
NFI4K 40/0.1	40	0.1	4	30.104.540	316	1
NFI4K 63/0.1	63	0.1	4	30.104.541	316	1
NFI4K 80/0.1	80	0.1	4	30.104.691	316	1
NFI4K 100/0.1	100	0.1	4	30.104.695	360	1
NFI4K 25/0.3	25	0.3	4	30.104.792	316	1
NFI4K 40/0.3	40	0.3	4	30.104.538	316	1
NFI4K 63/0.3	63	0.3	4	30.104.539	316	1
NFI4K 80/0.3	80	0.3	4	30.104.692	360	1
NFI4K 100/0.3	100	0.3	4	30.104.696	360	1
NFI4K 25/0.5	25	0.5	4	30.104.689	316	1
NFI4K 40/0.5	40	0.5	4	30.104.536	316	1
NFI4K 63/0.5	63	0.5	4	30.104.537	316	1
NFI4K 80/0.5	80	0.5	4	30.104.693	360	1
NFI4K 100/0.5	100	0.5	4	30.104.697	360	1



NOTE: Rated current 32 A on request

## ORDERING DATA

**NFI4K 25 / 0.03**



Rated residual operating current  $I_{\Delta n}$  (A)  
 Rated current  $I_n$  (A)  
 Number of poles  
 Type

ORDERING DATA



# RESIDUAL CURRENT CIRCUIT BREAKERS - NFIS

## TYPE A - SENSITIVE TO AC AND PULSATING DIRECT RESIDUAL CURRENTS

NFI2S - type A, selective **S**

Type	Rated current $I_n$ (A)	Rated residual current $I_{\Delta n}$ (A)	Number of poles	Ordering No.	Weight (g)	Packaging (pcs)
NFI2S 16/0.1	16	0.1	2	30.104.837	184	1
NFI2S 25/0.1	25	0.1	2	30.104.654	184	1
NFI2S 40/0.1	40	0.1	2	30.104.656	184	1
NFI2S 63/0.1	63	0.1	2	30.104.658	184	1
NFI2S 80/0.1	80	0.1	2	30.104.660	184	1
NFI2S 100/0.1	100	0.1	2	30.104.662	184	1
NFI2S 16/0.3	16	0.3	2	30.104.838	184	1
NFI2S 25/0.3	25	0.3	2	30.104.655	184	1
NFI2S 40/0.3	40	0.3	2	30.104.657	184	1
NFI2S 63/0.3	63	0.3	2	30.104.659	184	1
NFI2S 80/0.3	80	0.3	2	30.104.661	184	1
NFI2S 100/0.3	100	0.3	2	30.104.663	184	1
NFI2S 16/0.5	16	0.5	2	30.104.839	184	1
NFI2S 25/0.5	25	0.5	2	30.104.840	184	1
NFI2S 40/0.5	40	0.5	2	30.104.841	184	1
NFI2S 63/0.5	63	0.5	2	30.104.842	184	1
NFI2S 80/0.5	80	0.5	2	30.104.843	184	1
NFI2S 100/0.5	100	0.5	2	30.104.844	184	1



5

NFI4S - type A, selective **S**

Type	Rated current $I_n$ (A)	Rated residual current $I_{\Delta n}$ (A)	Number of poles	Ordering No.	Weight (g)	Packaging (pcs)
NFI4S 25/0.1	25	0.1	4	30.104.533	316	1
NFI4S 40/0.1	40	0.1	4	30.104.534	316	1
NFI4S 63/0.1	63	0.1	4	30.104.535	316	1
NFI4S 80/0.1	80	0.1	4	30.104.682	316	1
NFI4S 100/0.1	100	0.1	4	30.104.684	360	1
NFI4S 25/0.3	25	0.3	4	30.104.529	316	1
NFI4S 40/0.3	40	0.3	4	30.104.352	316	1
NFI4S 63/0.3	63	0.3	4	30.104.353	316	1
NFI4S 80/0.3	80	0.3	4	30.104.683	360	1
NFI4S 100/0.3	100	0.3	4	30.104.799	360	1
NFI4S 25/0.5	25	0.5	4	30.104.845	316	1
NFI4S 40/0.5	40	0.5	4	30.104.846	316	1
NFI4S 63/0.5	63	0.5	4	30.104.756	316	1
NFI4S 80/0.5	80	0.5	4	30.104.847	360	1
NFI4S 100/0.5	100	0.5	4	30.104.848	360	1



**NOTE:** Rated current 32 A on request

## ORDERING DATA

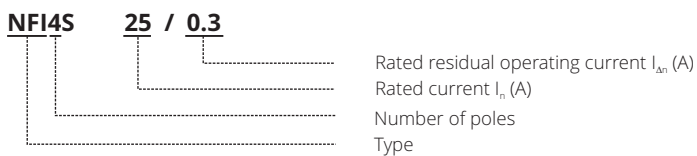

ORDERING DATA

# RESIDUAL CURRENT CIRCUIT BREAKERS - NFIF

## TYPE F - SENSITIVE TO RESIDUAL CURRENTS AS TYPE A AND IN ADDITION TO RESIDUAL CURRENTS WITH MIXED FREQUENCIES

NFI2F - type F, short-time delayed **G**

Type	Rated current $I_n$ (A)	Rated residual current $I_{\Delta n}$ (A)	Number of poles	Ordering No.	Weight (g)	Packaging (pcs)
NFI2F 16/0.03	16	0.03	2	30.104.850	184	1
NFI2F 25/0.03	25	0.03	2	30.104.851	184	1
NFI2F 40/0.03	40	0.03	2	30.104.852	184	1
NFI2F 63/0.03	63	0.03	2	30.104.853	184	1
NFI2F 80/0.03	80	0.03	2	30.104.854	184	1
NFI2F 100/0.03	100	0.03	2	30.104.855	184	1
NFI2F 16/0.1	16	0.1	2	30.104.856	184	1
NFI2F 25/0.1	25	0.1	2	30.104.857	184	1
NFI2F 40/0.1	40	0.1	2	30.104.858	184	1
NFI2F 63/0.1	63	0.1	2	30.104.859	184	1
NFI2F 80/0.1	80	0.1	2	30.104.860	184	1
NFI2F 100/0.1	100	0.1	2	30.104.861	184	1
NFI2F 16/0.3	16	0.3	2	30.104.862	184	1
NFI2F 25/0.3	25	0.3	2	30.104.863	184	1
NFI2F 40/0.3	40	0.3	2	30.104.864	184	1
NFI2F 63/0.3	63	0.3	2	30.104.865	184	1
NFI2F 80/0.3	80	0.3	2	30.104.866	184	1
NFI2F 100/0.3	100	0.3	2	30.104.867	184	1
NFI2F 16/0.5	16	0.5	2	30.104.868	184	1
NFI2F 25/0.5	25	0.5	2	30.104.869	184	1
NFI2F 40/0.5	40	0.5	2	30.104.870	184	1
NFI2F 63/0.5	63	0.5	2	30.104.871	184	1
NFI2F 80/0.5	80	0.5	2	30.104.872	184	1
NFI2F 100/0.5	100	0.5	2	30.104.873	184	1



5

NFI4F - type F, short-time delayed **G**

Type	Rated current $I_n$ (A)	Rated residual current $I_{\Delta n}$ (A)	Number of poles	Ordering No.	Weight (g)	Packaging (pcs)
NFI4F 25/0.03	25	0.03	4	30.104.875	316	1
NFI4F 40/0.03	40	0.03	4	30.104.876	316	1
NFI4F 63/0.03	63	0.03	4	30.104.877	316	1
NFI4F 80/0.03	80	0.03	4	30.104.878	316	1
NFI4F 100/0.03	100	0.03	4	30.104.879	360	1
NFI4F 25/0.1	25	0.1	4	30.104.880	316	1
NFI4F 40/0.1	40	0.1	4	30.104.881	316	1
NFI4F 63/0.1	63	0.1	4	30.104.882	316	1
NFI4F 80/0.1	80	0.1	4	30.104.883	316	1
NFI4F 100/0.1	100	0.1	4	30.104.884	360	1
NFI4F 25/0.3	25	0.3	4	30.104.885	316	1
NFI4F 40/0.3	40	0.3	4	30.104.886	316	1
NFI4F 63/0.3	63	0.3	4	30.104.887	316	1
NFI4F 80/0.3	80	0.3	4	30.104.888	360	1
NFI4F 100/0.3	100	0.3	4	30.104.889	360	1
NFI4F 25/0.5	25	0.5	4	30.104.890	316	1
NFI4F 40/0.5	40	0.5	4	30.104.891	316	1
NFI4F 63/0.5	63	0.5	4	30.104.892	316	1
NFI4F 80/0.5	80	0.5	4	30.104.893	360	1
NFI4F 100/0.5	100	0.5	4	30.104.894	360	1



NOTE: Rated current 32 A on request

## ORDERING DATA

**NFI4F 25 / 0.03**



Rated residual operating current  $I_{\Delta n}$  (A)  
 Rated current  $I_n$  (A)  
 Number of poles  
 Type

ORDERING DATA

# RESIDUAL CURRENT CIRCUIT BREAKERS - NFI, NFIK, NFIS

Type	A G S	Symbol	Unit	NFI2 NFI2K NFI2S	NFI4 NFI4K NFI4S
Standards				IEC/EN 61008, type G acc. to ÖVE E 8601	
Approvals				VDE, EAC	
Module width				2	4
Number of poles				2	4
Rated voltage		$U_n$	V	230	400
Rated insulation voltage		$U_i$	V	400	
Rated impulse withstand voltage		$U_{imp}$	kV	4	
Rated frequency		$f$	Hz	50	
Rated current		$I_n$	A	16, 25, 32, 40, 63, 80, 100	25, 32, 40, 63, 80, 100
Rated residual current		$I_{\Delta n}$	mA	10 ( $I_n = 16, 25, 32 A$ ), 30, 100, 300, 500	10 ( $I_n = 25, 32 A$ ), 30, 100, 300, 500
Residual operating current (AC 50 Hz)				0.5 - 1.0 $I_{\Delta n}$	
Rated conditional short-circuit current		$I_{nc}$	kA	10	
Rated making and breaking capacity		$I_m$	A	800 ( $I_n = 16 - 80 A$ )	
Rated residual making and breaking capacity		$I_{\Delta m}$	A	1000 ( $I_n = 100 A$ )	
Max. back-up fuse for short-circuit current gL		$I_v$	A	63 ( $I_n = 16 - 40 A$ ) 80 ( $I_n = 63, 80 A$ ) 100 ( $I_n = 100 A$ )	
Surge current withstand capability			A	NFI: 200 (0.5 $\mu$ s/100 kHz ring wave) NFIK, NFIS: 3000 (8/20 $\mu$ s surge current)	
Maximum breaking times				NFI, NFIK - $1 \times I_{\Delta n} : < 300$ ms; $5 \times I_{\Delta n} : < 40$ ms NFIS - $1 \times I_{\Delta n} : < 500$ ms; $5 \times I_{\Delta n} : < 150$ ms	
Minimum response time delay				FI, NFI: instantaneous NFIK: 10 ms NFIS: 40 ms	
Mechanical endurance			op. c.	min. 5000	
Electrical endurance			op. c.	min. 2000	
Ambient temperature			°C	-25 ... +40 *	
Storage temperature			°C	-35 ... +60	
Resistance to climate				acc. to IEC 60068-2-30: 28 cycles (55 °C, 95 % relative humidity)	
Terminal capacity rigid (solid or stranded) flexible		S	mm <sup>2</sup>	1 ... 35 1 ... 35	
Screw				M5	
Screw head				PZ2	
Tightening torque			Nm	2.0	
Length of removed conductor insulation			mm	15	
Degree of protection				IP20 (IP40 after installation in a distribution box)	
Pollution degree				2	
Weight			g	184	360

\* -35°C on request

5

TECHNICAL DATA

# RESIDUAL CURRENT CIRCUIT BREAKERS - NFIF

Type	F	Symbol	Unit	NFI2F	NFI4F
Standards				IEC/EN 61008, IEC/EN 62423	
Approvals				VDE	
Module width				2	4
Number of poles				2	4
Rated voltage		$U_n$	V	230	400
Rated insulation voltage		$U_i$	V	400	
Rated impulse withstand voltage		$U_{imp}$	kV	4	
Rated frequency		f	Hz	50	
Rated current		$I_n$	A	16, 25, 32, 40, 63, 80, 100	25, 32, 40, 63, 80, 100
Rated residual current		$I_{\Delta n}$	mA	30, 100, 300, 500	
Residual operating current (AC 50 Hz)				0.5 - 1.0 $I_{\Delta n}$	
Rated conditional short-circuit current		$I_{nc}$	kA	10	
Rated making and breaking capacity		$I_m$	A	800 ( $I_n = 16 - 80$ A)	
Rated residual making and breaking capacity		$I_{\Delta m}$	A	1000 ( $I_n = 100$ A)	
Max. back-up fuse for short-circuit current gL				63 ( $I_n = 16 - 40$ A) 80 ( $I_n = 63, 80$ A) 100 ( $I_n = 100$ A)	
Surge current withstand capability			kA	3 (8/20 $\mu$ s surge current)	
Maximum breaking times				1 x $I_{\Delta n}$ : < 300 ms; 5 x $I_{\Delta n}$ : < 40 ms	
Minimum response time delay				10 ms	
Mechanical endurance			op. c.	min. 5000	
Electrical endurance			op. c.	min. 2000	
Ambient temperature			°C	-25 ... +40	
Storage temperature			°C	-35 ... +60	
Resistance to climate				acc. to IEC 60068-2-30: 28 cycles (55 °C, 95 % relative humidity)	
Terminal capacity					
rigid (solid or stranded)		S	mm <sup>2</sup>	1 ... 35	
flexible				1 ... 35	
Screw				M5	
Screw head				PZ2	
Tightening torque			Nm	2.0	
Length of removed conductor insulation			mm	15	
Degree of protection				IP20 (IP40 after installation in a distribution box)	
Pollution degree				2	
Weight			g	184	360

5

TECHNICAL DATA

# RESIDUAL CURRENT CIRCUIT BREAKERS - TYPE A, TYPE F

NFI, NFIK, NFIS, NFIF

**NFI2, NFI2K  
NFI2S, NFI2F**

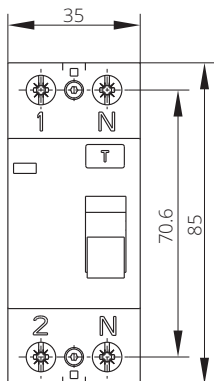

**NFI4, NFI4K  
NFI4S, NFI4F**

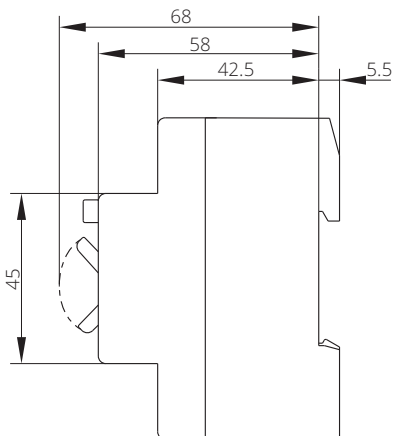
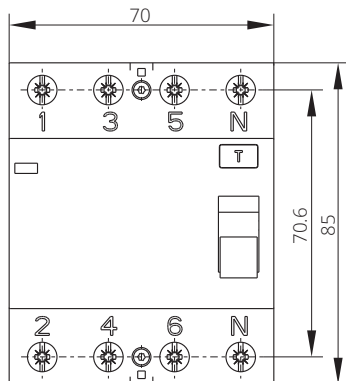

5

## Schematics

**NFI, NFIK, NFIS, NFIF**

**Two-pole**

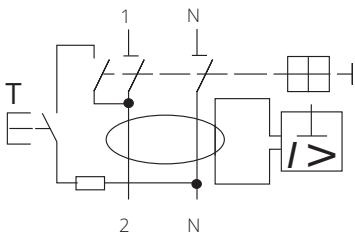

**Four-pole, N-pole right**

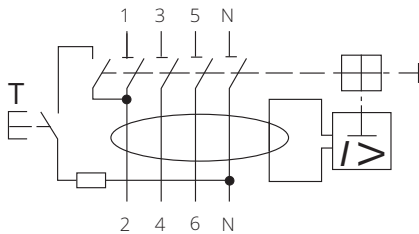

**Four-pole, N-pole left**

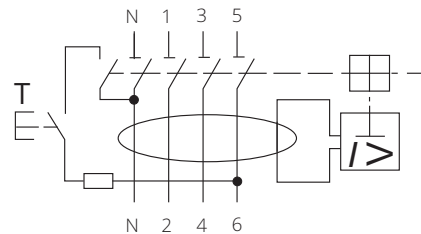

DIMENSIONS

# RESIDUAL CURRENT CIRCUIT BREAKERS - TYPE B

## NFIB



NFIB ARE TYPE B RESIDUAL CURRENT CIRCUIT BREAKERS (RCCBs) FOR WHICH TRIPPING IS ENSURED AS FOR TYPE A AND IN ADDITION FOR SMOOTH DC RESIDUAL CURRENTS, RESIDUAL DC CURRENTS WHICH MAY RESULT FROM RECTIFYING CIRCUITS, AND HIGH FREQUENCY AC RESIDUAL CURRENTS.



5

## FEATURES

- Intended for use in applications with frequency inverters, medical devices, UPS, mobile installations, elevators...
- The type B residual current circuit breakers are not intended for use in d.c. systems and networks with operating frequencies other than 50 or 60 Hz.
- For type B tripping conditions for frequencies up to 1 kHz are defined.
- Functions of detection, evaluation and interruption for type A residual currents do not depend on the line voltage. For evaluation of smooth d.c. residual currents supply voltage is required.
- **Versions:**
  - NFIBK: short-time delayed
  - NFIBS: selective type
- Surge current withstand capability with current waveform 8/20  $\mu$ s is 3 kA.
- When designing and installing electrical installations, electrical loads that can generate d.c. residual currents in the event of fault, must be assigned a separate electrical circuit.
- Optional operating position
- Degree of protection IP20; after installation in a distribution box IP40
- Assembly to a 35 mm wide mounting rail in accordance with EN 60715

## ORDERING DATA

Residual current circuit breakers up to 80 A ..... page 5-14

Connections ..... page 5-17

Example - Ordering data .....page 5-15

Technical characteristics ..... page 5-16

Dimensions ..... page 5-17

# RESIDUAL CURRENT CIRCUIT BREAKERS - NFIB

**TYPE B - SENSITIVE TO RESIDUAL CURRENTS AS TYPE F AND IN ADDITION TO SMOOTH DC RESIDUAL CURRENTS, RESIDUAL DC CURRENTS WHICH MAY RESULT FROM RECTIFYING CIRCUITS, AND HIGH FREQUENCY AC RESIDUAL CURRENTS**

NFI2BK - type B, short-time delayed **G**

Type	Rated current $I_n$ (A)	Rated residual current $I_{\Delta n}$ (A)	Number of poles	Ordering No.	Weight (g)	Packaging (pcs)
NFI2BK 25/0.03	25	0.03	2	30.105.110	310	1
NFI2BK 40/0.03	40	0.03	2	30.105.046	310	1
NFI2BK 63/0.03	63	0.03	2	30.105.035	310	1
NFI2BK 80/0.03	80	0.03	2	30.105.175	310	1
NFI2BK 25/0.1	25	0.1	2	30.105.176	310	1
NFI2BK 40/0.1	40	0.1	2	30.105.177	310	1
NFI2BK 63/0.1	63	0.1	2	30.105.178	310	1
NFI2BK 80/0.1	80	0.1	2	30.105.179	310	1
NFI2BK 25/0.3	25	0.3	2	30.105.180	310	1
NFI2BK 40/0.3	40	0.3	2	30.105.148	310	1
NFI2BK 63/0.3	63	0.3	2	30.105.181	310	1
NFI2BK 80/0.3	80	0.3	2	30.105.182	310	1
NFI2BK 25/0.5	25	0.5	2	30.105.183	310	1
NFI2BK 40/0.5	40	0.5	2	30.105.184	310	1
NFI2BK 63/0.5	63	0.5	2	30.105.185	310	1
NFI2BK 80/0.5	80	0.5	2	30.105.186	310	1



5

NFI4BK - type B, short-time delayed **G**

Type	Rated current $I_n$ (A)	Rated residual current $I_{\Delta n}$ (A)	Number of poles	Ordering No.	Weight (g)	Packaging (pcs)
NFI4BK 25/0.03	25	0.03	4	30.104.898	350	1
NFI4BK 40/0.03	40	0.03	4	30.104.899	350	1
NFI4BK 63/0.03	63	0.03	4	30.104.806	350	1
NFI4BK 80/0.03	80	0.03	4	30.104.902	350	1
NFI4BK 25/0.1	25	0.1	4	30.104.929	350	1
NFI4BK 40/0.1	40	0.1	4	30.104.930	350	1
NFI4BK 63/0.1	63	0.1	4	30.104.807	350	1
NFI4BK 80/0.1	80	0.1	4	30.104.903	350	1
NFI4BK 25/0.3	25	0.3	4	30.104.931	350	1
NFI4BK 40/0.3	40	0.3	4	30.104.932	350	1
NFI4BK 63/0.3	63	0.3	4	30.104.808	350	1
NFI4BK 80/0.3	80	0.3	4	30.104.904	350	1
NFI4BK 25/0.5	25	0.5	4	30.104.909	350	1
NFI4BK 40/0.5	40	0.5	4	30.104.933	350	1
NFI4BK 63/0.5	63	0.5	4	30.104.809	350	1
NFI4BK 80/0.5	80	0.5	4	30.104.905	350	1



NFI4BS - type B, selective **S**

Type	Rated current $I_n$ (A)	Rated residual current $I_{\Delta n}$ (A)	Number of poles	Ordering No.	Weight (g)	Packaging (pcs)
NFI4BS 25/0.1	25	0.1	4	30.104.934	350	1
NFI4BS 40/0.1	40	0.1	4	30.104.935	350	1
NFI4BS 63/0.1	63	0.1	4	30.104.810	350	1
NFI4BS 80/0.1	80	0.1	4	30.104.906	350	1
NFI4BS 25/0.3	25	0.3	4	30.104.936	350	1
NFI4BS 40/0.3	40	0.3	4	30.104.937	350	1
NFI4BS 63/0.3	63	0.3	4	30.104.811	350	1
NFI4BS 80/0.3	80	0.3	4	30.104.907	350	1
NFI4BS 25/0.5	25	0.5	4	30.104.910	350	1
NFI4BS 40/0.5	40	0.5	4	30.104.938	350	1
NFI4BS 63/0.5	63	0.5	4	30.104.812	350	1
NFI4BS 80/0.5	80	0.5	4	30.104.908	350	1



**NOTE:** Rated current 32 A on request

## ORDERING DATA

**NFI4BK 25 / 0.03**

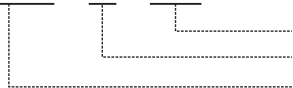

Rated residual operating current  $I_{\Delta n}$  (A)

Rated current  $I_n$  (A)

Type

ORDERING DATA

# RESIDUAL CURRENT CIRCUIT BREAKERS - NFIBK, NFIBS

Type	B	Symbol	Unit	NF12BK	NF14BK NF14BS
Standards				IEC/EN 61008, IEC/EN 62423	
Approvals				VDE, EAC	
Module width				4	
Number of poles				2	4
Rated voltage		$U_n$	V AC	230	400
Min. required operating voltage - for detecting type A residual currents - for detecting type B residual currents				0 V (mains voltage independent) 80 V AC 50 V AC	
Rated insulation voltage		$U_i$	V	400	
Rated impulse withstand voltage		$U_{imp}$	kV	4 (1.2/50 $\mu$ s)	
Rated frequency		f	Hz	50/60	
Rated current		$I_n$	A	25, 32, 40, 63, 80	
Rated residual current		$I_{\Delta n}$	mA	NF12BK, NF14BK: 30, 100, 300, 500 NF14BS: 100, 300, 500	
Residual operating current				AC (50 Hz): 0.5 - 1.0 $I_{\Delta n}$ DC: 0.5 - 2.0 $I_{\Delta n}$	
Frequency response range			Hz	0 - 1000	
Rated conditional short-circuit current		$I_{nc}$	kA	10	
Rated making and breaking capacity		$I_m$	A	800	
Rated residual making and breaking capacity		$I_{\Delta m}$	A	800	
Max. back-up fuse for short-circuit current gL		$I_v$	A	63 ( $I_n = 16 - 40$ A) 80 ( $I_n = 63, 80$ A)	
Surge current withstand capability			kA	3 (8/20 $\mu$ s surge current)	
Maximum breaking times				NF12BK, NF14BK - 1 x $I_{\Delta n}$ : < 300 ms; 5 x $I_{\Delta n}$ : < 40 ms NF14BS - 1 x $I_{\Delta n}$ : < 500 ms; 5 x $I_{\Delta n}$ : < 150 ms	
Minimum response time delay				NF12BK, NF14BK: 10 ms NF14BS: 40 ms	
Mechanical endurance			op. c.	min. 5000	
Electrical endurance			op. c.	min. 2000	
Ambient temperature			$^{\circ}$ C	-25 ... +40	
Storage temperature			$^{\circ}$ C	-35 ... +60	
Resistance to climate				acc. to IEC 60068-2-30: 28 cycles (55 $^{\circ}$ C, 95 % relative humidity)	
Terminal capacity rigid (solid or stranded) flexible		S	mm <sup>2</sup>	1 ... 25 1 ... 25	
Screw				M5	
Screw head				PZ2	
Tightening torque			Nm	2.0	
Length of removed conductor insulation			mm	15	
Degree of protection				IP20 (IP40 after installation in a distribution box)	
Pollution degree				2	
Weight			g	310	350

5

TECHNICAL DATA



# RESIDUAL CURRENT CIRCUIT BREAKERS - NFIBK, NFIBS

**NF12BK**

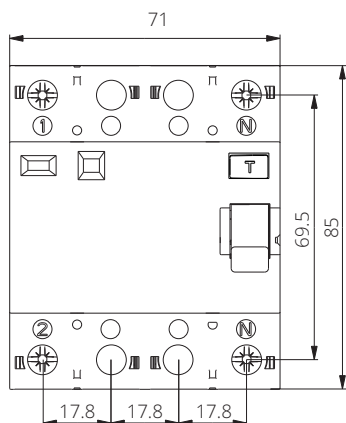

**NF14BK, NF14BS**

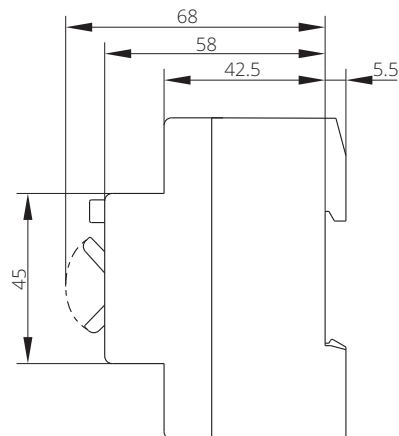
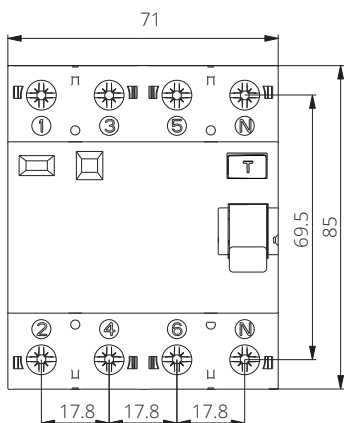

5

## Schematics

**NF12BK**

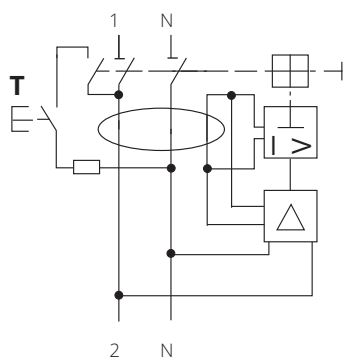

**NF14BK, NF14BS**

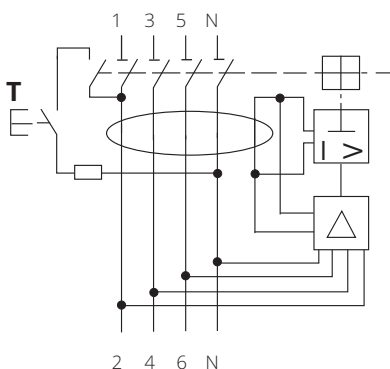

DIMENSIONS

# RESIDUAL CURRENT CIRCUIT BREAKERS - TYPE A

FI, FIK, FIS



RESIDUAL CURRENT CIRCUIT BREAKERS (RCCBs) ARE USED FOR PROTECTION AGAINST INDIRECT CONTACT, FIRE PROTECTION AND ADDITIONAL PROTECTION AGAINST DIRECT CONTACT. RCCBs TYPE A ARE SENSITIVE TO RESIDUAL SINUSOIDAL ALTERNATING CURRENTS AND RESIDUAL PULSATING DIRECT CURRENTS.

5

## FEATURES

- Suitable for isolation
- No overload protection or short-circuit protection is built in RCCB.
- Assembly to a 35 mm wide mounting rail in accordance with EN 60715
- Optional operation position
- Degree of protection IP20; degree of protection IP40 after installation in a distribution box
- Additional color display of the position of main contacts (red – contacts closed, green – contacts open)

## SPECIAL VERSIONS

### FIK - short-time delayed type

- Short-time delayed RCCB with minimum non-actuating time 10 ms (type G acc. to ÖVE E 8601)
- Surge current withstand capability with current waveform 8/20  $\mu$ s up to 3 kA
- High immunity against unwanted tripping at current impulses (e.g. a high number of fluorescent lamps, transient effects) or when installed in special critical conditions (leakage currents of impulse shape at long cables, the influence of storms, computers, X-ray devices, etc.).

### FIS - selective type

- Time delayed selective type with minimum non-actuating time 40 ms (type S)
- Surge current withstand capability with current waveform 8/20  $\mu$ s up to 3 kA
- Selectivity regarding a general type and a short-time delayed type is enabled
- Particularly suitable as the main RCCB

## ORDERING DATA

Residual current circuit breakers up to 125 A ..... page 5-18  
Connections ..... page 5-29

Example - Ordering data ..... page 5-20, 5-22, 5-23  
Technical characteristics ..... page 5-24  
Dimensions ..... page 5-29

# RESIDUAL CURRENT CIRCUIT BREAKERS - TYPE A

## TYPE A - SENSITIVE TO AC AND PULSATING DIRECT RESIDUAL CURRENTS

FI2 - type A, instantaneous tripping

Type	Rated current $I_n$ (A)	Rated residual current $I_{\Delta n}$ (A)	Number of poles	Ordering No.	Weight (g)	Packaging (pcs)
FI2 16/0.01	16	0.01	2	30.106.052	184	1
FI2 25/0.01	25	0.01	2	30.106.053	184	1
FI2 32/0.01	32	0.01	2	30.106.054	184	1
FI2 16/0.03	16	0.03	2	30.106.055	184	1
FI2 25/0.03	25	0.03	2	30.106.056	184	1
FI2 32/0.03	32	0.03	2	30.106.057	184	1
FI2 40/0.03	40	0.03	2	30.106.049	184	1
FI2 63/0.03	63	0.03	2	30.106.017	184	1
FI2 80/0.03	80	0.03	2	30.106.058	184	1
FI2 100/0.03	100	0.03	2	30.106.059	184	1
FI2 125/0.03	125	0.03	2	30.106.016	184	1
FI2 16/0.1	16	0.1	2	30.106.060	184	1
FI2 25/0.1	25	0.1	2	30.106.061	184	1
FI2 32/0.1	32	0.1	2	30.106.062	184	1
FI2 40/0.1	40	0.1	2	30.106.063	184	1
FI2 63/0.1	63	0.1	2	30.106.064	184	1
FI2 80/0.1	80	0.1	2	30.106.065	184	1
FI2 100/0.1	100	0.1	2	30.106.066	184	1
FI2 125/0.1	125	0.1	2	30.106.067	184	1
FI2 16/0.3	16	0.3	2	30.106.068	184	1
FI2 25/0.3	25	0.3	2	30.106.069	184	1
FI2 32/0.3	32	0.3	2	30.106.070	184	1
FI2 40/0.3	40	0.3	2	30.106.071	184	1
FI2 63/0.3	63	0.3	2	30.106.072	184	1
FI2 80/0.3	80	0.3	2	30.106.073	184	1
FI2 100/0.3	100	0.3	2	30.106.074	184	1
FI2 125/0.3	125	0.3	2	30.106.050	184	1
FI2 16/0.5	16	0.5	2	30.106.075	184	1
FI2 25/0.5	25	0.5	2	30.106.076	184	1
FI2 32/0.5	32	0.5	2	30.106.077	184	1
FI2 40/0.5	40	0.5	2	30.106.078	184	1
FI2 63/0.5	63	0.5	2	30.106.079	184	1
FI2 80/0.5	80	0.5	2	30.106.080	184	1
FI2 100/0.5	100	0.5	2	30.106.081	184	1
FI2 125/0.5	125	0.5	2	30.106.082	184	1



5

ORDERING DATA

# RESIDUAL CURRENT CIRCUIT BREAKERS - TYPE A

## TYPE A - SENSITIVE TO AC AND PULSATING DIRECT RESIDUAL CURRENTS

FI4 - type A, instantaneous tripping

Type	Rated current $I_n$ (A)	Rated residual current $I_{\Delta n}$ (A)	Number of poles	Ordering No.	Weight (g)	Packaging (pcs)
FI4 25/0.01	25	0.01	4	30.106.083	350	1
FI4 32/0.01	32	0.01	4	30.106.084	350	1
FI4 25/0.03	25	0.03	4	30.106.085	350	1
FI4 32/0.03	32	0.03	4	30.106.086	350	1
FI4 40/0.03	40	0.03	4	30.106.046	350	1
FI4 63/0.03	63	0.03	4	30.106.013	350	1
FI4 80/0.03	80	0.03	4	30.106.087	350	1
FI4 100/0.03	100	0.03	4	30.106.088	350	1
FI4 125/0.03	125	0.03	4	30.106.012	350	1
FI4 25/0.1	25	0.1	4	30.106.089	350	1
FI4 32/0.1	32	0.1	4	30.106.090	350	1
FI4 40/0.1	40	0.1	4	30.106.091	350	1
FI4 63/0.1	63	0.1	4	30.106.092	350	1
FI4 80/0.1	80	0.1	4	30.106.093	350	1
FI4 100/0.1	100	0.1	4	30.106.094	350	1
FI4 125/0.1	125	0.1	4	30.106.095	350	1
FI4 25/0.3	25	0.3	4	30.106.096	350	1
FI4 32/0.3	32	0.3	4	30.106.097	350	1
FI4 40/0.3	40	0.3	4	30.106.098	350	1
FI4 63/0.3	63	0.3	4	30.106.099	350	1
FI4 80/0.3	80	0.3	4	30.106.100	350	1
FI4 100/0.3	100	0.3	4	30.106.101	350	1
FI4 125/0.3	125	0.3	4	30.106.027	350	1
FI4 25/0.5	25	0.5	4	30.106.030	350	1
FI4 32/0.5	32	0.5	4	30.106.102	350	1
FI4 40/0.5	40	0.5	4	30.106.103	350	1
FI4 63/0.5	63	0.5	4	30.106.104	350	1
FI4 80/0.5	80	0.5	4	30.106.105	350	1
FI4 100/0.5	100	0.5	4	30.106.106	350	1
FI4 125/0.5	125	0.5	4	30.106.107	350	1



5

## ORDERING DATA

**FI4 25 / 0.03**

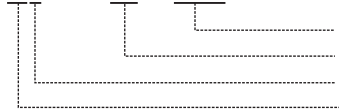

Rated residual operating current  $I_{\Delta n}$  (A)  
 Rated current  $I_n$  (A)  
 Number of poles  
 Type

ORDERING DATA

# RESIDUAL CURRENT CIRCUIT BREAKERS - TYPE A

## TYPE A - SENSITIVE TO AC AND PULSATING DIRECT RESIDUAL CURRENTS

FI2K - type A, short-time delayed **G**



Type	Rated current $I_n$ (A)	Rated residual current $I_{\Delta n}$ (A)	Number of poles	Ordering No.	Weight (g)	Packaging (pcs)
FI2K 16/0.03	16	0.03	2	30.106.033	184	1
FI2K 25/0.03	25	0.03	2	30.106.108	184	1
FI2K 32/0.03	32	0.03	2	30.106.109	184	1
FI2K 40/0.03	40	0.03	2	30.106.110	184	1
FI2K 63/0.03	63	0.03	2	30.106.111	184	1
FI2K 80/0.03	80	0.03	2	30.106.112	184	1
FI2K 100/0.03	100	0.03	2	30.106.113	184	1
FI2K 125/0.03	125	0.03	2	30.106.026	184	1
FI2K 16/0.1	16	0.1	2	30.106.114	184	1
FI2K 25/0.1	25	0.1	2	30.106.115	184	1
FI2K 32/0.1	32	0.1	2	30.106.116	184	1
FI2K 40/0.1	40	0.1	2	30.106.117	184	1
FI2K 63/0.1	63	0.1	2	30.106.118	184	1
FI2K 80/0.1	80	0.1	2	30.106.119	184	1
FI2K 100/0.1	100	0.1	2	30.106.120	184	1
FI2K 125/0.1	125	0.1	2	30.106.121	184	1
FI2K 16/0.3	16	0.3	2	30.106.122	184	1
FI2K 25/0.3	25	0.3	2	30.106.123	184	1
FI2K 32/0.3	32	0.3	2	30.106.124	184	1
FI2K 40/0.3	40	0.3	2	30.106.125	184	1
FI2K 63/0.3	63	0.3	2	30.106.126	184	1
FI2K 80/0.3	80	0.3	2	30.106.127	184	1
FI2K 100/0.3	100	0.3	2	30.106.128	184	1
FI2K 125/0.3	125	0.3	2	30.106.129	184	1
FI2K 16/0.5	16	0.5	2	30.106.130	184	1
FI2K 25/0.5	25	0.5	2	30.106.131	184	1
FI2K 32/0.5	32	0.5	2	30.106.132	184	1
FI2K 40/0.5	40	0.5	2	30.106.133	184	1
FI2K 63/0.5	63	0.5	2	30.106.134	184	1
FI2K 80/0.5	80	0.5	2	30.106.135	184	1
FI2K 100/0.5	100	0.5	2	30.106.136	184	1
FI2K 125/0.5	125	0.5	2	30.106.137	184	1



5

ORDERING DATA

# RESIDUAL CURRENT CIRCUIT BREAKERS - TYPE A

## TYPE A - SENSITIVE TO AC AND PULSATING DIRECT RESIDUAL CURRENTS

FI4K - type A, short-time delayed 



Type	Rated current $I_n$ (A)	Rated residual current $I_{\Delta n}$ (A)	Number of poles	Ordering No.	Weight (g)	Packaging (pcs)
FI4K 25/0.03	25	0.03	4	30.106.138	350	1
FI4K 32/0.03	32	0.03	4	30.106.139	350	1
FI4K 40/0.03	40	0.03	4	30.106.140	350	1
FI4K 63/0.03	63	0.03	4	30.106.141	350	1
FI4K 80/0.03	80	0.03	4	30.106.142	350	1
FI4K 100/0.03	100	0.03	4	30.106.143	350	1
FI4K 125/0.03	125	0.03	4	30.106.025	350	1
FI4K 25/0.1	25	0.1	4	30.106.144	350	1
FI4K 32/0.1	32	0.1	4	30.106.145	350	1
FI4K 40/0.1	40	0.1	4	30.106.146	350	1
FI4K 63/0.1	63	0.1	4	30.106.147	350	1
FI4K 80/0.1	80	0.1	4	30.106.148	350	1
FI4K 100/0.1	100	0.1	4	30.106.149	350	1
FI4K 125/0.1	125	0.1	4	30.106.150	350	1
FI4K 25/0.3	25	0.3	4	30.106.151	350	1
FI4K 32/0.3	32	0.3	4	30.106.152	350	1
FI4K 40/0.3	40	0.3	4	30.106.153	350	1
FI4K 63/0.3	63	0.3	4	30.106.154	350	1
FI4K 80/0.3	80	0.3	4	30.106.155	350	1
FI4K 100/0.3	100	0.3	4	30.106.156	350	1
FI4K 125/0.3	125	0.3	4	30.106.157	350	1
FI4K 25/0.5	25	0.5	4	30.106.158	350	1
FI4K 32/0.5	32	0.5	4	30.106.159	350	1
FI4K 40/0.5	40	0.5	4	30.106.160	350	1
FI4K 63/0.5	63	0.5	4	30.106.161	350	1
FI4K 80/0.5	80	0.5	4	30.106.162	350	1
FI4K 100/0.5	100	0.5	4	30.106.163	350	1
FI4K 125/0.5	125	0.5	4	30.106.164	350	1



5

### ORDERING DATA

**FI4K 25 / 0.03**

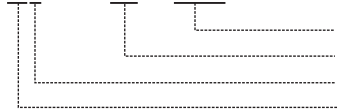

Rated residual operating current  $I_{\Delta n}$  (A)  
 Rated current  $I_n$  (A)  
 Number of poles  
 Type

ORDERING DATA

# RESIDUAL CURRENT CIRCUIT BREAKERS - TYPE A

## TYPE A - SENSITIVE TO AC AND PULSATING DIRECT RESIDUAL CURRENTS

FI2S - type A, selective **S**

Type	Rated current $I_n$ (A)	Rated residual current $I_{\Delta n}$ (A)	Number of poles	Ordering No.	Weight (g)	Packaging (pcs)
FI2S 16/0.1	16	0.1	2	30.106.165	184	1
FI2S 25/0.1	25	0.1	2	30.106.166	184	1
FI2S 32/0.1	32	0.1	2	30.106.167	184	1
FI2S 40/0.1	40	0.1	2	30.106.168	184	1
FI2S 63/0.1	63	0.1	2	30.106.044	184	1
FI2S 80/0.1	80	0.1	2	30.106.169	184	1
FI2S 100/0.1	100	0.1	2	30.106.170	184	1
FI2S 125/0.1	125	0.1	2	30.106.042	184	1
FI2S 16/0.3	16	0.3	2	30.106.171	184	1
FI2S 25/0.3	25	0.3	2	30.106.172	184	1
FI2S 32/0.3	32	0.3	2	30.106.173	184	1
FI2S 40/0.3	40	0.3	2	30.106.174	184	1
FI2S 63/0.3	63	0.3	2	30.106.175	184	1
FI2S 80/0.3	80	0.3	2	30.106.176	184	1
FI2S 100/0.3	100	0.3	2	30.106.177	184	1
FI2S 125/0.3	125	0.3	2	30.106.178	184	1
FI2S 16/0.5	16	0.5	2	30.106.179	184	1
FI2S 25/0.5	25	0.5	2	30.106.180	184	1
FI2S 32/0.5	32	0.5	2	30.106.181	184	1
FI2S 40/0.5	40	0.5	2	30.106.182	184	1
FI2S 63/0.5	63	0.5	2	30.106.183	184	1
FI2S 80/0.5	80	0.5	2	30.106.184	184	1
FI2S 100/0.5	100	0.5	2	30.106.185	184	1
FI2S 125/0.5	125	0.5	2	30.106.186	184	1



5

FI4S - type A, selective **S**

Type	Rated current $I_n$ (A)	Rated residual current $I_{\Delta n}$ (A)	Number of poles	Ordering No.	Weight (g)	Packaging (pcs)
FI4S 25/0.1	25	0.1	4	30.106.187	350	1
FI4S 32/0.1	32	0.1	4	30.106.188	350	1
FI4S 40/0.1	40	0.1	4	30.106.189	350	1
FI4S 63/0.1	63	0.1	4	30.106.038	350	1
FI4S 80/0.1	80	0.1	4	30.106.190	350	1
FI4S 100/0.1	100	0.1	4	30.106.191	350	1
FI4S 125/0.1	125	0.1	4	30.106.036	350	1
FI4S 25/0.3	25	0.3	4	30.106.192	350	1
FI4S 32/0.3	32	0.3	4	30.106.193	350	1
FI4S 40/0.3	40	0.3	4	30.106.194	350	1
FI4S 63/0.3	63	0.3	4	30.106.195	350	1
FI4S 80/0.3	80	0.3	4	30.106.196	350	1
FI4S 100/0.3	100	0.3	4	30.106.197	350	1
FI4S 125/0.3	125	0.3	4	30.106.198	350	1
FI4S 25/0.5	25	0.5	4	30.106.040	350	1
FI4S 32/0.5	32	0.5	4	30.106.199	350	1
FI4S 40/0.5	40	0.5	4	30.106.200	350	1
FI4S 63/0.5	63	0.5	4	30.106.201	350	1
FI4S 80/0.5	80	0.5	4	30.106.202	350	1
FI4S 100/0.5	100	0.5	4	30.106.203	350	1
FI4S 125/0.5	125	0.5	4	30.106.204	350	1



## ORDERING DATA



ORDERING DATA

# RESIDUAL CURRENT CIRCUIT BREAKERS - FI, FIK, FIS

Type	A G S	Symbol	Unit	F12 F12K F12S	F14 F14K F14S
Standards				IEC/EN 61008, type G acc. to ÖVE E 8601	
Module width				2	4
Number of poles				2	4
Rated voltage		$U_n$	V	230	400
Rated insulation voltage		$U_i$	V	400	
Rated impulse withstand voltage		$U_{imp}$	kV	4	
Rated frequency		$f$	Hz	50	
Rated current		$I_n$	A	16, 25, 32, 40, 63, 80, 100, 125	25, 32, 40, 63, 80, 100, 125
Rated residual current		$I_{\Delta n}$	mA	10 ( $I_n = 16, 25, 32$ A), 30, 100, 300, 500	10 ( $I_n = 25, 32$ A), 30, 100, 300, 500
Residual operating current (AC 50 Hz)				0.5 - 1.0 $I_{\Delta n}$	
Rated conditional short-circuit current		$I_{nc}$	kA	10	
Rated making and breaking capacity		$I_m$	A	630 ( $I_n = 16 - 63$ A)	
Rated residual making and breaking capacity		$I_{\Delta m}$	A	1250 ( $I_n = 80 - 125$ A)	
Max. back-up fuse for short-circuit current gL		$I_v$	A	63 ( $I_n = 16 - 63$ A) 125 ( $I_n = 80 - 125$ A)	
Surge current withstand capability			A	FI: 200 (0.5 $\mu$ s/100 kHz ring wave) FIK, FIS: 3000 (8/20 $\mu$ s surge current)	
Maximum breaking times				FI, FIK - 1 x $I_{\Delta n}$ : < 300 ms; 5 x $I_{\Delta n}$ : < 40 ms FIS - 1 x $I_{\Delta n}$ : < 500 ms; 5 x $I_{\Delta n}$ : < 150 ms	
Minimum response time delay				FI: instantaneous FIK: 10 ms FIS: 40 ms	
Mechanical endurance			op. c.	min. 5000	
Electrical endurance			op. c.	min. 2000	
Ambient temperature			°C	-25 ... +40	
Storage temperature			°C	-35 ... +60	
Resistance to climate				acc. to IEC 60068-2-30: 28 cycles (55 °C, 95 % relative humidity)	
Terminal capacity rigid (solid or stranded)		S	mm <sup>2</sup>	1 ... 50	
flexible				1 ... 50	
Screw				M6	
Screw head				PZ2	
Tightening torque			Nm	nominal 2.5 / maximal 5.0	
Length of removed conductor insulation			mm	15	
Degree of protection				IP20 (IP40 after installation in a distribution box)	
Pollution degree				2	
Weight			g	184	350

5

TECHNICAL DATA



FIF



FIF ARE TYPE F RESIDUAL CURRENT CIRCUIT BREAKERS (RCCBs) FOR WHICH TRIPPING IS ENSURED AS FOR TYPE A AND IN ADDITION FOR RESIDUAL CURRENTS WITH MIXED FREQUENCIES UP TO 1 kHz THAT CAN RESULT FROM SINGLE-PHASE ELECTRICAL LOADS WITH FREQUENCY INVERTERS.

5

## FEATURES

- Short-time delayed RCCB with minimum non-actuating time 10 ms
- The tripping characteristic of type F is not influenced by smooth direct residual currents up to 10 mA.
- Functions of detection, evaluation and interruption do not depend on the line voltage.
- Intended for protection when using washing machines, vacuum cleaners, dishwashers, heating pumps, lighting system ...
- Suitable for isolation
- No overload protection or short-circuit protection is built in RCCB.
- Assembly to a 35 mm wide mounting rail in accordance with EN 60715
- Optional operation position
- Degree of protection IP20; degree of protection IP40 after installation in a distribution box
- Additional color display of the position of main contacts (red – contacts closed, green – contacts open)

## ORDERING DATA

Residual current circuit breakers up to 125 A ..... page 5-25

Connections ..... page 5-29

Example - Ordering data ..... page 5-27

Technical characteristics ..... page 5-28

Dimensions ..... page 5-29

# RESIDUAL CURRENT CIRCUIT BREAKERS - TYPE F

TYPE F - SENSITIVE TO RESIDUAL CURRENTS AS TYPE A AND IN ADDITION TO RESIDUAL CURRENTS WITH MIXED FREQUENCIES

FI2F - type F, short-time delayed 



Type	Rated current $I_n$ (A)	Rated residual current $I_{\Delta n}$ (A)	Number of poles	Ordering No.	Weight (g)	Packaging (pcs)
FI2F 16/0.03	16	0.03	2	30.106.205	184	1
FI2F 25/0.03	25	0.03	2	30.106.206	184	1
FI2F 32/0.03	32	0.03	2	30.106.207	184	1
FI2F 40/0.03	40	0.03	2	30.106.208	184	1
FI2F 63/0.03	63	0.03	2	30.106.209	184	1
FI2F 80/0.03	80	0.03	2	30.106.210	184	1
FI2F 100/0.03	100	0.03	2	30.106.211	184	1
FI2F 125/0.03	125	0.03	2	30.106.034	184	1
FI2F 16/0.1	16	0.1	2	30.106.212	184	1
FI2F 25/0.1	25	0.1	2	30.106.213	184	1
FI2F 32/0.1	32	0.1	2	30.106.214	184	1
FI2F 40/0.1	40	0.1	2	30.106.215	184	1
FI2F 63/0.1	63	0.1	2	30.106.216	184	1
FI2F 80/0.1	80	0.1	2	30.106.217	184	1
FI2F 100/0.1	100	0.1	2	30.106.218	184	1
FI2F 125/0.1	125	0.1	2	30.106.219	184	1
FI2F 16/0.3	16	0.3	2	30.106.220	184	1
FI2F 25/0.3	25	0.3	2	30.106.221	184	1
FI2F 32/0.3	32	0.3	2	30.106.222	184	1
FI2F 40/0.3	40	0.3	2	30.106.223	184	1
FI2F 63/0.3	63	0.3	2	30.106.224	184	1
FI2F 80/0.3	80	0.3	2	30.106.225	184	1
FI2F 100/0.3	100	0.3	2	30.106.226	184	1
FI2F 125/0.3	125	0.3	2	30.106.227	184	1
FI2F 16/0.5	16	0.5	2	30.106.228	184	1
FI2F 25/0.5	25	0.5	2	30.106.229	184	1
FI2F 32/0.5	32	0.5	2	30.106.230	184	1
FI2F 40/0.5	40	0.5	2	30.106.231	184	1
FI2F 63/0.5	63	0.5	2	30.106.232	184	1
FI2F 80/0.5	80	0.5	2	30.106.233	184	1
FI2F 100/0.5	100	0.5	2	30.106.234	184	1
FI2F 125/0.5	125	0.5	2	30.106.235	184	1



5

ORDERING DATA

# RESIDUAL CURRENT CIRCUIT BREAKERS - TYPE F

**TYPE F - SENSITIVE TO RESIDUAL CURRENTS AS TYPE A AND IN ADDITION TO RESIDUAL CURRENTS WITH MIXED FREQUENCIES**

FI4F - type F, short-time delayed 



Type	Rated current $I_n$ (A)	Rated residual current $I_{\Delta n}$ (A)	Number of poles	Ordering No.	Weight (g)	Packaging (pcs)
FI4F 25/0.03	25	0.03	4	30.106.236	350	1
FI4F 32/0.03	32	0.03	4	30.106.237	350	1
FI4F 40/0.03	40	0.03	4	30.106.238	350	1
FI4F 63/0.03	63	0.03	4	30.106.239	350	1
FI4F 80/0.03	80	0.03	4	30.106.240	350	1
FI4F 100/0.03	100	0.03	4	30.106.241	350	1
FI4F 125/0.03	125	0.03	4	30.106.032	350	1
FI4F 25/0.1	25	0.1	4	30.106.242	350	1
FI4F 32/0.1	32	0.1	4	30.106.243	350	1
FI4F 40/0.1	40	0.1	4	30.106.244	350	1
FI4F 63/0.1	63	0.1	4	30.106.245	350	1
FI4F 80/0.1	80	0.1	4	30.106.246	350	1
FI4F 100/0.1	100	0.1	4	30.106.247	350	1
FI4F 125/0.1	125	0.1	4	30.106.248	350	1
FI4F 25/0.3	25	0.3	4	30.106.249	350	1
FI4F 32/0.3	32	0.3	4	30.106.250	350	1
FI4F 40/0.3	40	0.3	4	30.106.251	350	1
FI4F 63/0.3	63	0.3	4	30.106.252	350	1
FI4F 80/0.3	80	0.3	4	30.106.253	350	1
FI4F 100/0.3	100	0.3	4	30.106.254	350	1
FI4F 125/0.3	125	0.3	4	30.106.255	350	1
FI4F 25/0.5	25	0.5	4	30.106.256	350	1
FI4F 32/0.5	32	0.5	4	30.106.257	350	1
FI4F 40/0.5	40	0.5	4	30.106.258	350	1
FI4F 63/0.5	63	0.5	4	30.106.259	350	1
FI4F 80/0.5	80	0.5	4	30.106.260	350	1
FI4F 100/0.5	100	0.5	4	30.106.261	350	1
FI4F 125/0.5	125	0.5	4	30.106.262	350	1



5

## ORDERING DATA

**FI4F 25 / 0.03**

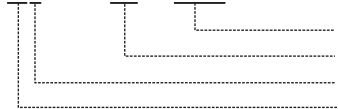

Rated residual operating current  $I_{\Delta n}$  (A)  
 Rated current  $I_n$  (A)  
 Number of poles  
 Type

ORDERING DATA

# RESIDUAL CURRENT CIRCUIT BREAKERS - TYPE F

Type	F	Symbol	Unit	F12F	F14F
Standards				IEC/EN 61008, IEC/EN 62423	
Module width				2	4
Number of poles				2	4
Rated voltage		$U_n$	V	230	400
Rated insulation voltage		$U_i$	V	400	
Rated impulse withstand voltage		$U_{imp}$	kV	4	
Rated frequency		$f$	Hz	50	
Rated current		$I_n$	A	16, 25, 32, 40, 63, 80, 100, 125	25, 32, 40, 63, 80, 100, 125
Rated residual current		$I_{\Delta n}$	mA	30, 100, 300, 500	
Residual operating current (AC 50 Hz)				0.5 - 1.0 $I_{\Delta n}$	
Rated conditional short-circuit current		$I_{nc}$	kA	10	
Rated making and breaking capacity		$I_m$	A	630 ( $I_n = 16 - 63$ A)	
Rated residual making and breaking capacity		$I_{Bm}$	A	1250 ( $I_n = 80 - 125$ A)	
Max. back-up fuse for short-circuit current gL		$I_v$	A	63 ( $I_n = 16 - 63$ A) 125 ( $I_n = 80 - 125$ A)	
Surge current withstand capability			kA	3 (8/20 $\mu$ s surge current)	
Maximum breaking times				1 x $I_{\Delta n}$ : < 300 ms; 5 x $I_{\Delta n}$ : < 40 ms	
Minimum response time delay				10 ms	
Mechanical endurance			op. c.	min. 5000	
Electrical endurance			op. c.	min. 2000	
Ambient temperature			°C	-25 ... +40	
Storage temperature			°C	-35 ... +60	
Resistance to climate				acc. to IEC 60068-2-30: 28 cycles (55 °C, 95 % relative humidity)	
Terminal capacity					
rigid (solid or stranded)		S	mm <sup>2</sup>	1 ... 50	
flexible				1 ... 50	
Screw				M6	
Screw head				PZ2	
Tightening torque			Nm	nominal 2.5 / maximal 5.0	
Length of removed conductor insulation			mm	15	
Degree of protection				IP20 (IP40 after installation in a distribution box)	
Pollution degree				2	
Weight			g	184	350

# RESIDUAL CURRENT CIRCUIT BREAKERS - TYPE A, TYPE F

FI, FIK, FIS, FIF

**FI2, FI2K  
FI2S, FI2F**

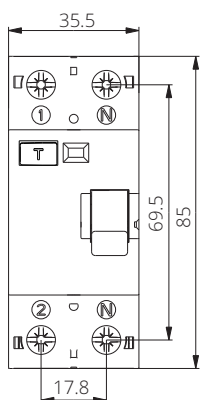

**FI4, FI4K, FI4S, FI4F**

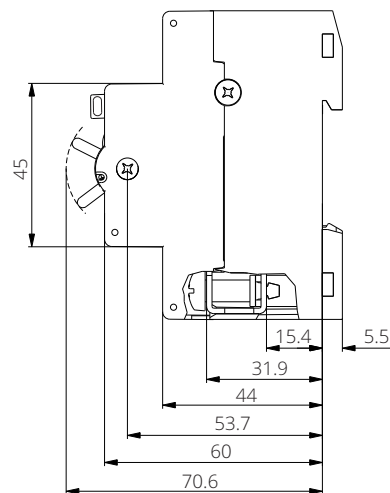
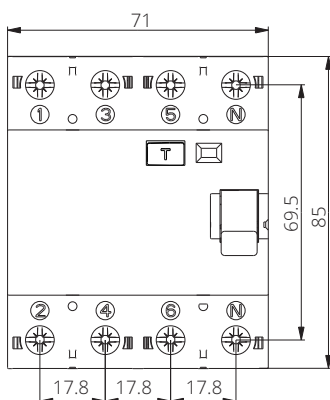

## Schematics

**FI2, FI2K, FI2S, FI2F**

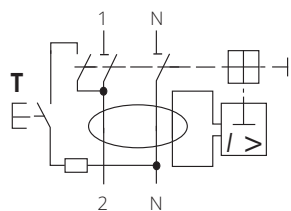

**FI4, FI4K, FI4S, FI4F**

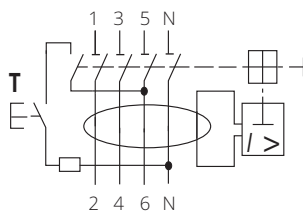

**FI4-L, FI4K-L, FI4S-L, FI4F-L**

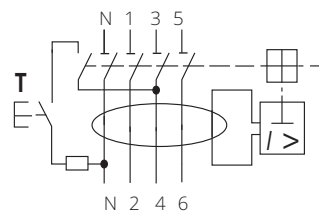

5

DIMENSIONS

# RESIDUAL CURRENT CIRCUIT BREAKERS - TYPE B

FIBK, FIBS



FIB ARE TYPE B RESIDUAL CURRENT CIRCUIT BREAKERS (RCCBs) FOR WHICH TRIPPING IS ENSURED AS FOR TYPE F AND IN ADDITION FOR SMOOTH DC RESIDUAL CURRENTS, RESIDUAL PULSATING RECTIFIED DIRECT CURRENTS WHICH MAY RESULT FROM TWO OR MORE PHASES, AND HIGH FREQUENCY AC RESIDUAL CURRENTS.

5

## FEATURES

- Intended for use in applications with frequency inverters, medical devices, ups, mobile installations, elevators...
- The type B residual current circuit breakers are not intended for use in d.c. systems and networks with operating frequencies other than 50 or 60 Hz.
- For type B tripping conditions for frequencies up to 1 kHz are defined.
- Functions of detection, evaluation and interruption for type A residual currents do not depend on the line voltage.
- For evaluation of DC residual currents supply voltage is required.
- **Versions:**
  - FIBK: short-time delayed tripping
  - FIBS: selective type
- When designing and installing electrical installations, electrical loads that can generate d.c. residual currents in the event of fault, must be assigned a separate electrical circuit.
- Suitable for isolation
- No overload protection or short-circuit protection is built in RCCB.
- Assembly to a 35 mm wide mounting rail in accordance with EN 60715
- Optional operation position
- Degree of protection IP20; degree of protection IP40 after installation in a distribution box
- Additional color display of the position of main contacts (red – contacts closed, green – contacts open)

## ORDERING DATA

Residual current circuit breakers up to 125 A ..... page 5-30

Connections ..... page 5-35

Example - Ordering data ..... page 5-33

Technical characteristics ..... page 5-34

Dimensions ..... page 5-35

# RESIDUAL CURRENT CIRCUIT BREAKERS - TYPE B

**TYPE B - SENSITIVE TO RESIDUAL CURRENTS AS TYPE F AND IN ADDITION TO SMOOTH DC RESIDUAL CURRENTS, RESIDUAL DC CURRENTS WHICH MAY RESULT FROM RECTIFYING CIRCUITS, AND HIGH FREQUENCY AC RESIDUAL CURRENTS**

FI2BK - type B, short-time delayed



Type	Rated current $I_n$ (A)	Rated residual current $I_{\Delta n}$ (A)	Number of poles	Ordering No.	Weight (g)	Packaging (pcs)
FI2BK 25/0.03	25	0.03	2	30.106.267	210	1
FI2BK 32/0.03	32	0.03	2	30.106.268	210	1
FI2BK 40/0.03	40	0.03	2	30.106.265	210	1
FI2BK 63/0.03	63	0.03	2	30.106.021	210	1
FI2BK 80/0.03	80	0.03	2	30.106.271	210	1
FI2BK 100/0.03	100	0.03	2	30.106.269	350	1
FI2BK 125/0.03	125	0.03	2	30.106.020	350	1
FI2BK 25/0.1	25	0.1	2	30.106.272	210	1
FI2BK 32/0.1	32	0.1	2	30.106.273	210	1
FI2BK 40/0.1	40	0.1	2	30.106.274	210	1
FI2BK 63/0.1	63	0.1	2	30.106.275	210	1
FI2BK 80/0.1	80	0.1	2	30.106.276	210	1
FI2BK 100/0.1	100	0.1	2	30.106.277	350	1
FI2BK 125/0.1	125	0.1	2	30.106.278	350	1
FI2BK 25/0.3	25	0.3	2	30.106.279	210	1
FI2BK 32/0.3	32	0.3	2	30.106.280	210	1
FI2BK 40/0.3	40	0.3	2	30.106.281	210	1
FI2BK 63/0.3	63	0.3	2	30.106.282	210	1
FI2BK 80/0.3	80	0.3	2	30.106.283	210	1
FI2BK 100/0.3	100	0.3	2	30.106.284	350	1
FI2BK 125/0.3	125	0.3	2	30.106.285	350	1
FI2BK 25/0.5	25	0.5	2	30.106.286	210	1
FI2BK 32/0.5	32	0.5	2	30.106.287	210	1
FI2BK 40/0.5	40	0.5	2	30.106.288	210	1
FI2BK 63/0.5	63	0.5	2	30.106.289	210	1
FI2BK 80/0.5	80	0.5	2	30.106.290	210	1
FI2BK 100/0.5	100	0.5	2	30.106.291	350	1
FI2BK 125/0.5	125	0.5	2	30.106.292	350	1



5



ORDERING DATA

# RESIDUAL CURRENT CIRCUIT BREAKERS - TYPE B

**TYPE B - SENSITIVE TO RESIDUAL CURRENTS AS TYPE F AND IN ADDITION TO SMOOTH DC RESIDUAL CURRENTS, RESIDUAL DC CURRENTS WHICH MAY RESULT FROM RECTIFYING CIRCUITS, AND HIGH FREQUENCY AC RESIDUAL CURRENTS**

FI4BK - type B, short-time delayed



Type	Rated current I <sub>n</sub> (A)	Rated residual current I <sub>Δn</sub> (A)	Number of poles	Ordering No.	Weight (g)	Packaging (pcs)
FI4BK 25/0.03	25	0.03	4	30.106.293	350	1
FI4BK 32/0.03	32	0.03	4	30.106.294	350	1
FI4BK 40/0.03	40	0.03	4	30.106.295	350	1
FI4BK 63/0.03	63	0.03	4	30.106.019	350	1
FI4BK 80/0.03	80	0.03	4	30.106.296	350	1
FI4BK 100/0.03	100	0.03	4	30.106.297	350	1
FI4BK 125/0.03	125	0.03	4	30.106.018	350	1
FI4BK 25/0.1	25	0.1	4	30.106.298	350	1
FI4BK 32/0.1	32	0.1	4	30.106.299	350	1
FI4BK 40/0.1	40	0.1	4	30.106.300	350	1
FI4BK 63/0.1	63	0.1	4	30.106.301	350	1
FI4BK 80/0.1	80	0.1	4	30.106.302	350	1
FI4BK 100/0.1	100	0.1	4	30.106.303	350	1
FI4BK 125/0.1	125	0.1	4	30.106.304	350	1
FI4BK 25/0.3	25	0.3	4	30.106.305	350	1
FI4BK 32/0.3	32	0.3	4	30.106.306	350	1
FI4BK 40/0.3	40	0.3	4	30.106.307	350	1
FI4BK 63/0.3	63	0.3	4	30.106.308	350	1
FI4BK 80/0.3	80	0.3	4	30.106.309	350	1
FI4BK 100/0.3	100	0.3	4	30.106.310	350	1
FI4BK 125/0.3	125	0.3	4	30.106.311	350	1
FI4BK 25/0.5	25	0.5	4	30.106.312	350	1
FI4BK 32/0.5	32	0.5	4	30.106.313	350	1
FI4BK 40/0.5	40	0.5	4	30.106.314	350	1
FI4BK 63/0.5	63	0.5	4	30.106.315	350	1
FI4BK 80/0.5	80	0.5	4	30.106.316	350	1
FI4BK 100/0.5	100	0.5	4	30.106.317	350	1
FI4BK 125/0.5	125	0.5	4	30.106.318	350	1



5

ORDERING DATA



# RESIDUAL CURRENT CIRCUIT BREAKERS - TYPE B

**TYPE B - SENSITIVE TO RESIDUAL CURRENTS AS TYPE F AND IN ADDITION TO SMOOTH DC RESIDUAL CURRENTS, RESIDUAL DC CURRENTS WHICH MAY RESULT FROM RECTIFYING CIRCUITS, AND HIGH FREQUENCY AC RESIDUAL CURRENTS**

FI4BS - type B, selective S

Type	Rated current $I_n$ (A)	Rated residual current $I_{\Delta n}$ (A)	Number of poles	Ordering No.	Weight (g)	Packaging (pcs)
FI4BS 25/0.1	25	0.1	4	30.106.319	350	1
FI4BS 32/0.1	32	0.1	4	30.106.320	350	1
FI4BS 40/0.1	40	0.1	4	30.106.321	350	1
FI4BS 63/0.1	63	0.1	4	30.106.322	350	1
FI4BS 80/0.1	80	0.1	4	30.106.323	350	1
FI4BS 100/0.1	100	0.1	4	30.106.324	350	1
FI4BS 125/0.1	125	0.1	4	30.106.325	350	1
FI4BS 25/0.3	25	0.3	4	30.106.326	350	1
FI4BS 32/0.3	32	0.3	4	30.106.327	350	1
FI4BS 40/0.3	40	0.3	4	30.106.328	350	1
FI4BS 63/0.3	63	0.3	4	30.106.329	350	1
FI4BS 80/0.3	80	0.3	4	30.106.330	350	1
FI4BS 100/0.3	100	0.3	4	30.106.331	350	1
FI4BS 125/0.3	125	0.3	4	30.106.332	350	1
FI4BS 25/0.5	25	0.5	4	30.106.333	350	1
FI4BS 32/0.5	32	0.5	4	30.106.334	350	1
FI4BS 40/0.5	40	0.5	4	30.106.335	350	1
FI4BS 63/0.5	63	0.5	4	30.106.336	350	1
FI4BS 80/0.5	80	0.5	4	30.106.337	350	1
FI4BS 100/0.5	100	0.5	4	30.106.338	350	1
FI4BS 125/0.5	125	0.5	4	30.106.339	350	1



5

## ORDERING DATA

**FI4BK 25 / 0.03**

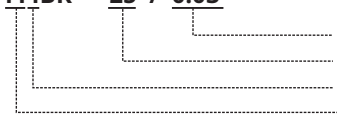

Rated residual operating current  $I_{\Delta n}$  (A)  
 Rated current  $I_n$  (A)  
 Number of poles  
 Type

ORDERING DATA

# RESIDUAL CURRENT CIRCUIT BREAKERS - FIBK, FIBS

Type	B	Symbol	Unit	F12BK	F12BK F14BK F14BS
Standards				IEC/EN 61008	IEC/EN 62423
Module width				2	4
Number of poles				2 ( $I_n = 25 - 80$ A)	F12BK: 2 ( $I_n = 100, 125$ A) F14BK, F14BS: 4
Rated voltage		$U_n$	V	230	400
Min. required operating voltage				0 V (mains voltage independent)	
- for detecting type A residual currents				80 V AC	50 V AC
- for detecting type B residual currents					
Rated insulation voltage		$U_i$	V	400	
Rated impulse withstand voltage		$U_{imp}$	kV	4 (1.2 / 50 $\mu$ s)	
Rated frequency		f	Hz	50/60	
Rated current		$I_n$	A	25, 32, 40, 63, 80	25, 32, 40, 63, 80, 100, 125
Rated residual current		$I_{\Delta n}$	mA	F12BK, F14BK: 30, 100, 300, 500 F14BS: 100, 300, 500	
Residual operating current				AC (50 Hz): 0.5 - 1.0 $I_{\Delta n}$ DC: 0.5 - 2.0 $I_{\Delta n}$	
Frequency response range		f	Hz	0 - 1000	
Rated conditional short-circuit current		$I_{nc}$	kA	10	
Rated making and breaking capacity		$I_m$	A	800	630 ( $I_n = 16 - 63$ A)
Rated residual making and breaking capacity		$I_{\Delta m}$	A		1250 ( $I_n = 80 - 125$ A)
Max. back-up fuse for short-circuit current gL		$I_v$	A	80	63 ( $I_n = 16 - 32$ A) 125 ( $I_n = 80 - 125$ A)
Surge current withstand capability			A	3 (8/20 $\mu$ s surge current)	
Maximum breaking times				F2BK, F14BK - 1 x $I_{\Delta n}$ : < 300 ms; 5 x $I_{\Delta n}$ : < 40 ms F14BS - 1 x $I_{\Delta n}$ : < 500 ms; 5 x $I_{\Delta n}$ : < 150 ms	
Minimum response time delay				F12BK, F14BK: 10 ms F14BS: 40 ms	
Mechanical endurance			op. c.	min. 5000	
Electrical endurance			op. c.	min. 2000	
Ambient temperature			°C	-25 ... +40	
Storage temperature			°C	-35 ... +60	
Resistance to climate				acc. to IEC 60068-2-30: 28 cycles (55 °C, 95 % relative humidity)	
Terminal capacity					
rigid (solid or stranded)		S	mm <sup>2</sup>	1 ... 50	
flexible				1 ... 50	
Screw				M6	
Screw head				PZ2	
Tightening torque			Nm	nominal 2.5 / maximal 5.0	
Length of removed conductor insulation			mm	15	
Degree of protection				IP20 (IP40 after installation in a distribution box)	
Pollution degree				2	
Weight			g	210	380

5

TECHNICAL DATA

# RESIDUAL CURRENT CIRCUIT BREAKERS - FIBK, FIBS

FI2BK, FI4BK, FI4BS

**FI2BK**  
( $I_n = 25 - 80 \text{ A}$ )

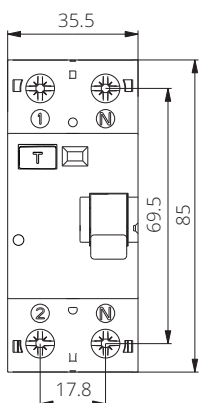

**FI4BK  
FI4BS**

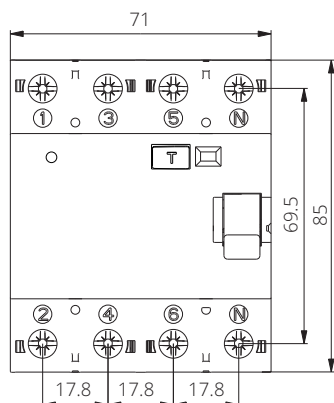

**FI2BK**  
( $I_n = 100 - 125 \text{ A}$ )

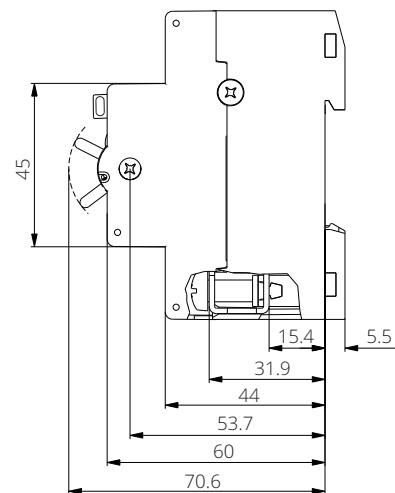
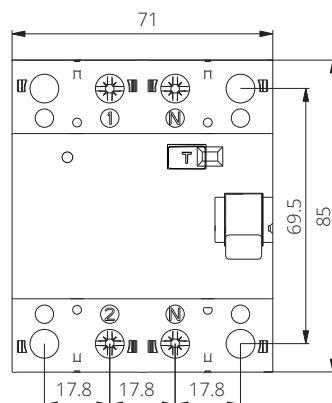

5

## Schematics

**FI2BK**

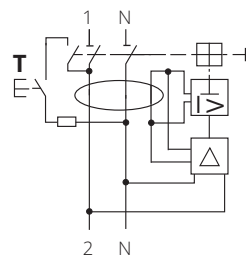

**FI4BK, FI4BS**

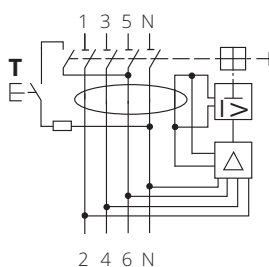

DIMENSIONS

# RESIDUAL CURRENT CIRCUIT BREAKERS - ACCESSORIES

FIN (suitable just for versions FI, FIK, FIS, FIF, FIBK, FIBS)

Auxiliary switch - AC-15 acc. to IEC/EN 60947-5-1 (2-pole, ½ module)

Type	Rated current I <sub>n</sub>	Wiring diagram				Ordering No.	Weight (g)	Packaging (pcs)
		-20	-11	-02	-1C			
FIN20	6 A					38.423.668	31	1
FIN11	6 A					38.423.669	31	
FIN02	6 A					38.423.670	31	
FIN1C	6 A					38.423.671	31	



5

Mounting positions of accessories

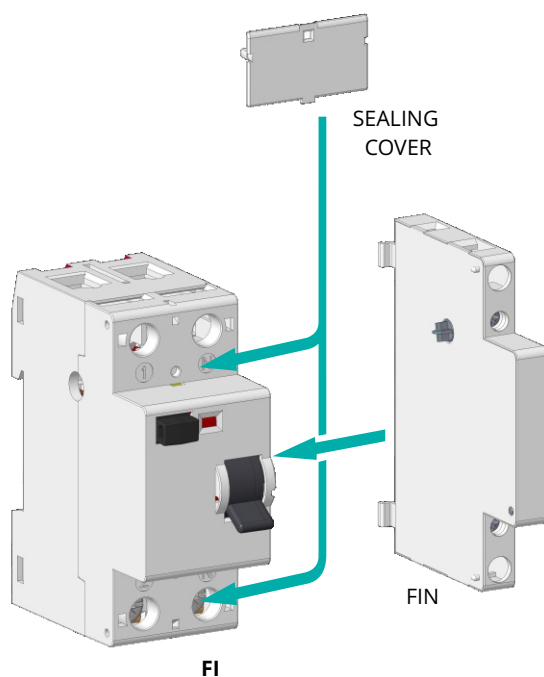

ORDERING DATA

# RESIDUAL CURRENT CIRCUIT BREAKERS - ACCESSORIES

## Auxiliary switch - FIN

	GENERAL		FIN	
	Type	Symbol	Unit	
Standards				IEC/EN 60947-1, IEC/EN 60947-5-1, IEC/EN 62019, DIN EN 62019 (VDE 0640)
Approvals				CE
Module width				0.5
Number of poles				2
Degree of protection				IP20
Pollution degree				2
Ambient temperature:		°C		-25 °C ... +55 °C
Storage temperature				-40 °C ... +80 °C
Maximum altitude		m		≤ 2000
Mechanical endurance		op. c.		10.000
Weight		g		31
Contact reliability				≥12 V; ≥10 mA ≥24 V; ≥5 mA
Minimum distance of open contacts		mm		3
Power dissipation per pole		W		0.3
Maximum back-up fuse for short-circuit protection gL and gG: MCB 6 A, characteristic B, I <sub>cn</sub> = 6 kA or I <sub>cn</sub> = 10 kA	I <sub>v</sub>	A		6
Rated insulation voltage	U <sub>i</sub>	V		400
Rated impulse withstand voltage	U <sub>imp</sub>	kV		4
Rated operational voltage	U <sub>e</sub>	V		230 / 400 V AC 220 V DC
Rated frequency	f	Hz		50/60; DC
Thermal current	I <sub>th</sub>	A		6
Rated operational current for AC-12: single-phase 230 V single-phase 400 V	I <sub>e</sub>	A		6 4
Electrical endurance for AC-12		op. c.		5.000
Rated operational current for AC-13: single-phase 230 V single-phase 400 V	I <sub>e</sub>	A		6 4
Electrical endurance for AC-13		op. c.		5.000
Rated operational current for AC-14: single-phase 230 V single-phase 400 V	I <sub>e</sub>	A		5 3
Electrical endurance for AC-14		op. c.		5.000
Rated operational current for AC-15: single-phase 230 V single-phase 400 V	I <sub>e</sub>	A		4 2
Electrical endurance for AC-15		op. c.		5.000
Rated operational current for DC-12: 1 pole ... 24 VDC / 48 VDC / 60 VDC / 110 VDC / 220 VDC	I <sub>e</sub>	A		6/4/3/1.5/1
Electrical endurance for DC-12		op. c.		5.000
Rated operational current for DC-13: 2 pole ... 24 VDC / 48 VDC / 60 VDC / 110 VDC / 220 VDC	I <sub>e</sub>	A		6/4/2/0.3/0.05
Electrical endurance for DC-13		op. c.		5.000
Terminal capacity: rigid (solid and stranded) flexible flexible (termination)	S	mm <sup>2</sup>		0.75 ... 2.5 1 ... 2.5 0.75 ... 1.5
Screw				M3
Screw head				PZ1
Tightening torque		Nm		0.8

5

TECHNICAL DATA

FIN

