



# Product Specification

G156HAN02.3

AU OPTRONICS CORPORATION

( ) Preliminary Specifications

(✓) Final Specifications

Module	15.6" FHD Color TFT-LCD
Model Name	G156HAN02.302
Note	LED backlight with driving circuit design

<b>Customer</b>	<b>Date</b>
_____	_____
<b>Checked &amp; Approved by</b>	<b>Date</b>
_____	_____
<b>Customer's sign back page</b>	

<b>Approved by</b>	<b>Date</b>
<u>Sean Lin</u>	<u>03/20/2020</u>
<b>Prepared by</b>	<b>Date</b>
<u>Sandy Su</u>	<u>03/20/2020</u>
<b>General Display Business Division / AU Optronics corporation</b>	



Contents

**1. Handling Precautions ..... 4**

**2. General Description ..... 5**

    2.1 General Specification ..... 5

    2.2 Optical Characteristics ..... 6

**3. Functional Block Diagram ..... 9**

**4. Absolute Maximum Ratings ..... 10**

    4.1 Absolute Ratings of TFT LCD Module ..... 10

    4.2 Absolute Ratings of Environment ..... 10

    5.1 TFT LCD Module ..... 11

    5.2 Backlight Unit ..... 13

**6. Signal Interface Characteristic ..... 16**

    6.1 Pixel Format Image ..... 16

    6.2 Signal Description ..... 17

    6.3 The Input Data Format ..... 19

    6.4 Interface Timing ..... 20

    6.5 Power ON/OFF Sequence ..... 21

**7. Panel Reliability Test ..... 22**

**8. Mechanical Characteristics ..... 23**

    8.1 LCM Outline Dimension (Front View) ..... 23

    8.2 LCM Outline Dimension (Rear View) ..... 24

**9. Label and Packaging ..... 25**

    9.1 Shipping Label (on the rear side of TFT-LCD display) ..... 25

    9.2 Carton Package ..... 26

    9.3 Shipping Package of Palletizing Sequence ..... 26

**10. Safety ..... 27**

    10.1 Sharp Edge Requirements ..... 27

    10.2 Materials ..... 27

    10.3 Capacitors ..... 27

    10.4 National Test Lab Requirement ..... 27

**11. Handling guide ..... 28**



Record of Revision

Version	Date	Page	Old description	New Description
1.0	2020/03/20	All	Final Edition Release for Customer	

AUO Confidential  
For PROMATE Internal Use Only  
20200505 13:36:46

AUO Confidential  
For PROMATE Internal Use Only  
20200505 13:36:46

AUO Confidential  
For PROMATE Internal Use Only  
20200505 13:36:46



## 1. Handling Precautions

- 1) Since front polarizer is easily damaged, please be cautious and not to scratch it.
- 2) Be sure to turn off power supply when inserting or disconnecting from input connector.
- 3) Wipe off water drop immediately. Long contact with water may cause discoloration or spots.
- 4) When the panel surface is soiled, wipe it with absorbent cotton or soft cloth.
- 5) Since the panel is made of glass, it may be broken or cracked if dropped or bumped on hard surface.
- 6) To avoid ESD (Electro Static Discharge) damage, be sure to ground yourself before handling TFT-LCD Module.
- 7) Do not open nor modify the module assembly.
- 8) Do not press the reflector sheet at the back of the module to any direction.
- 9) In case if a module has to be put back into the packing container slot after it was taken out from the container, do not press the center of the LED light bar edge. Instead, press at the far ends of the LED light bar edge softly. Otherwise the TFT Module may be damaged.
- 10) At the insertion or removal of the Signal Interface Connector, be sure not to rotate nor tilt the Interface Connector of the TFT Module.
- 11) TFT-LCD Module is not allowed to be twisted & bent even force is added on module in a very short time. Please design your display product well to avoid external force applying to module by end-user directly.
- 12) Small amount of materials having no flammability grade is used in the LCD module. The LCD module should be supplied by power complied with requirements of Limited Power Source (IEC60950 or UL1950), or be applied exemption.
- 13) Severe temperature condition may result in different luminance, response time and lamp ignition voltage.
- 14) Continuous operating TFT-LCD display under low temperature environment may accelerate lamp exhaustion and reduce luminance dramatically.
- 15) The data on this specification sheet is applicable when LCD module is placed in landscape position.
- 16) Continuous displaying fixed pattern may induce image sticking. It's recommended to use screen saver or shuffle content periodically if fixed pattern is displayed on the screen.



## 2. General Description

G156HAN02.3 is a Color Active Matrix Liquid Crystal Display composed of a TFT LCD panel, a driver circuit, and LED backlight system. The screen format is intended to support the 16:9 FHD, 1920(H) x 1080(V) screen and 16.7M colors (RGB 8-bits )with LED backlight driving circuit. All input signals are LVDS interface compatible.

G156HAN02.3 is designed for a display unit of notebook style personal computer and industrial machine.

### 2.1 General Specification

The following items are characteristics summary on the table at 25 °C condition

Items	Unit	Specifications			
Screen Diagonal	[mm]	15.6"			
Active Area	[mm]	344.16 x 193.59			
Resolution		1920 x 3(RGB) x 1080			
Pixel Pitch	[mm]	0.17925 x 0.17925			
Pixel Arrangement		R.G.B. Vertical Stripe			
Display Mode		AHVA, Normally Black			
Nominal Input Voltage VDD	[Volt]	+3.3 (Typ.)			
LCD Power Consumption	[Watt]	2.11 (Max.)			
Backlight Power Consumption	[Watt]	10.4 (Max.)			
Weight	[Grams]	600 (Typ), 660 (Max)			
Physical Size Include bracket	[mm]		<b>Min.</b>	<b>Typ.</b>	<b>Max.</b>
		<b>Length</b>	363.3	363.8	364.3
		<b>Width</b>	215.4	215.9	216.4
		<b>Thickness</b>		8.8	
Electrical Interface		2 ch LVDS			
Surface Treatment		Anti-glare, 3H			
Support Color		16.7M colors ( RGB 8-bits)			
Temperature Range Operating Storage (Non-Operating)	[°C]	<b>-20 to +70</b>			
	[°C]	<b>-20 to +70</b>			
RoHS Compliance		Yes			



## 2.2 Optical Characteristics

The optical characteristics are measured under stable conditions at 25°C (Room Temperature)

Item	Unit	Conditions	Min.	Typ.	Max.	Note
White Luminance	cd/m <sup>2</sup>	I <sub>LED</sub> =50mA Center average	400	500	-	1, 2
Luminance Uniformity	%	9 Points	75	80		1, 2, 3
Contrast Ratio	--		700	1000	-	1, 4
Response Time	msec	Rising + Falling	-	25	35	1, 5
Viewing Angle	degree	Horizontal (Right) CR = 10 (Left)	80 80	89 89	- -	1, 6
		Vertical (Upper) CR = 10 (Lower)	80 80	89 89	- -	
Color / Chromaticity Coodinates (CIE 1931)	Red	Rx	0.589	0.639	0.689	4
		Ry	0.283	0.333	0.383	
	Green	Gx	0.252	0.302	0.352	
		Gy	0.574	0.624	0.674	
	Blue	Bx	0.107	0.157	0.207	
		By	0.008	0.058	0.108	
	White	Wx	0.263	0.313	0.363	
		Wy	0.279	0.329	0.379	
Color Gamut	%		-	72	-	

**Note 1:** Measurement method

Equipment Pattern Generator, Power Supply, Digital Voltmeter, Luminance meter (SR\_3 or equivalent)

- Aperture 1° with 50cm viewing distance
- Test Point Center
- Environment < 1 lux

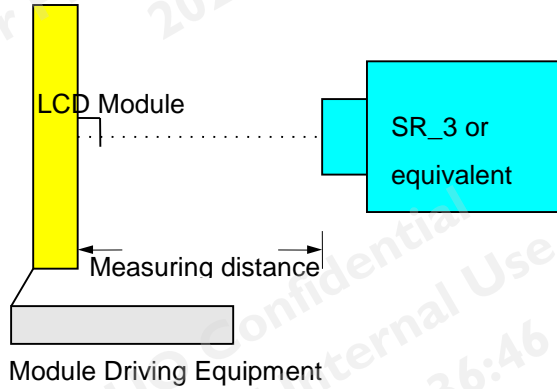

**Note 2:** 9 points position

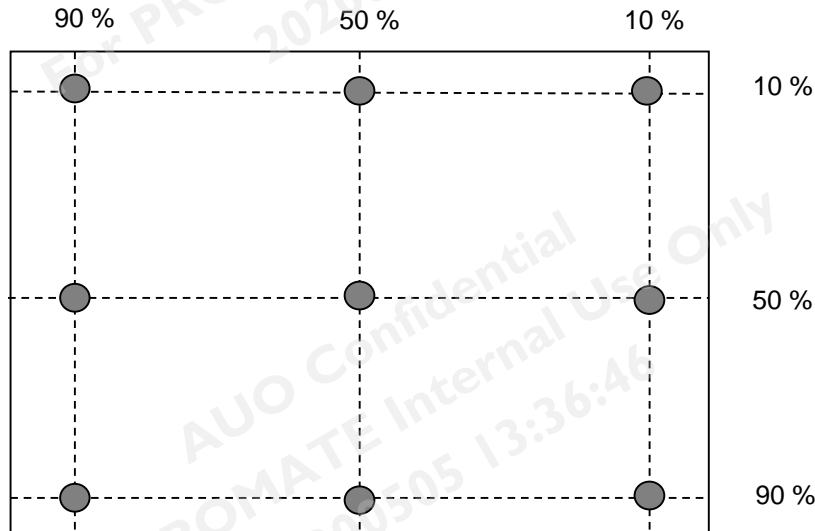

**Note 3:** The luminance uniformity of 9 points is defined by dividing the maximum luminance values by the minimum test point luminance. And measured by TOPCON SR-3

$$\delta w_9 = \frac{\text{Minimum Luminance of 9 points}}{\text{Maximum Luminance of 9 points}}$$

**Note 4 :** Definition of contrast ratio:

Contrast ratio is calculated with the following formula.

$$\text{Contrast ratio (CR)} = \frac{\text{Brightness on the "White" state}}{\text{Brightness on the "Black" state}}$$

**Note 5:** Definition of response time:

The output signals of BM-7 or equivalent are measured when the input signals are changed from "Black" to "White" (falling time) and from "White" to "Black" (rising time), respectively. The response time interval between the 10% and 90% of amplitudes. Refer to figure as below.

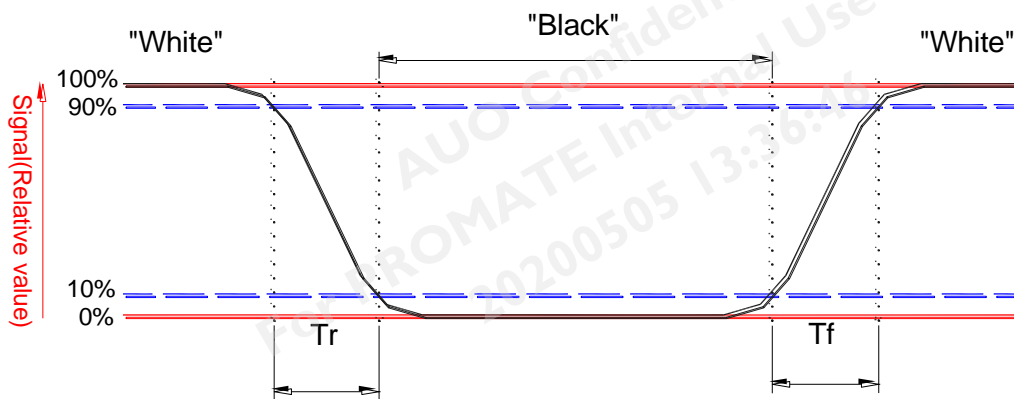

**Note 6:.** Definition of viewing angle

Viewing angle is the measurement of contrast ratio  $\geq 10$ , at the screen center, over a 180° horizontal and 180° vertical range (off-normal viewing angles). The 180° viewing angle range is broken down as follows; 90° ( $\theta$ ) horizontal left and right and 90° ( $\phi$ ) vertical, high (up) and low (down). The measurement direction is typically perpendicular to the display surface with the screen rotated about its center to develop the desired measurement viewing angle.

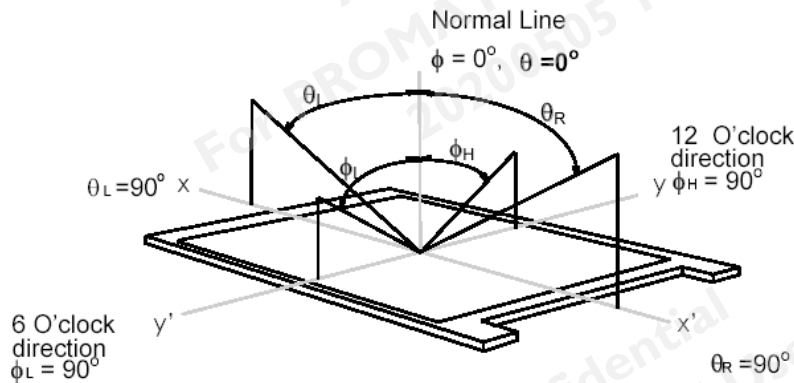



## 3. Functional Block Diagram

The following diagram shows the functional block of the 15.6 inches wide Color TFT/LCD module.

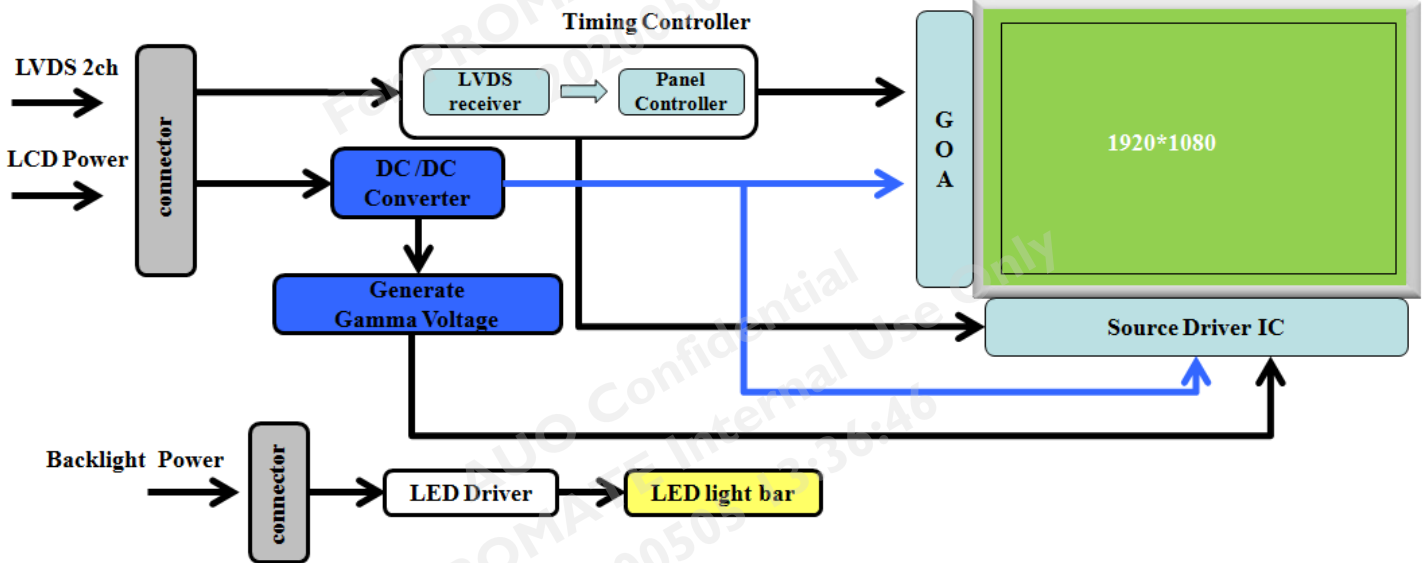

## 4. Absolute Maximum Ratings

An absolute maximum rating of the module is as following:

### 4.1 Absolute Ratings of TFT LCD Module

Item	Symbol	Min	Max	Unit
Logic/LCD Drive	VDD	-0.3	+4.0	[Volt]

### 4.2 Absolute Ratings of Environment

Item	Symbol	Min	Max	Unit
Operating	TOP	-20	+70	[°C]
Operation Humidity	HOP	5	95	[%RH]
Storage Temperature	TST	-20	+70	[°C]
Storage Humidity	HST	5	95	[%RH]

Note: Maximum Wet-Bulb should be 39 °C and no condensation.

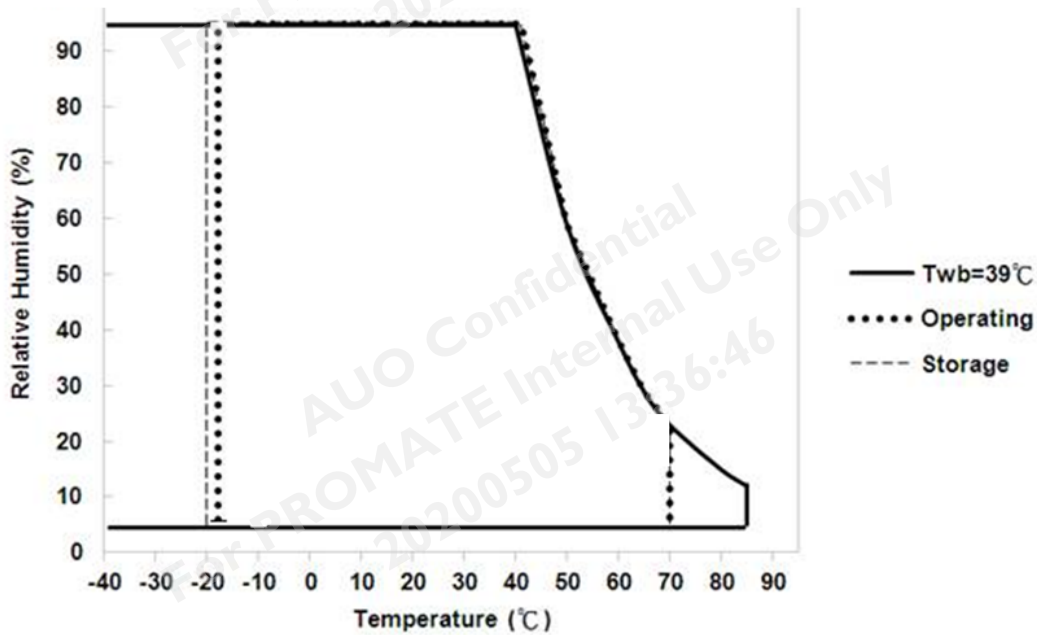

## 5. Electrical Characteristics

### 5.1 TFT LCD Module

#### 5.1.1 Power Specification

Input power specifications are as follows;

The power specification are measured under 25°C and frame frequency under 60Hz

Symble	Parameter	Min	Typ	Max	Units	Remark
VDD	Logic/LCD Drive Voltage	3.0	3.3	3.6	[Volt]	
PDD	VDD Power	-	1.75	2.11	[Watt]	All White Pattern (VDD=3.3V, at 60Hz), Note 1
IDD	IDD Current	-	0.53	0.64	[A]	All White Pattern (VDD=3.3V, at 60Hz) Note 2
IRush	Inrush Current	-	-	2000	[mA]	Note 1
VDDrp	Allowable Logic/LCD Drive Ripple Voltage	-	-	100	[mV] p-p	All White Pattern (VDD=3.3V, at 60Hz)

**Note 1** : Maximum Measurement Condition : White Pattern at 3.3V driving voltage. (Pmax=V3.3 x Iwhite)

Typical Measurement Condition: Mosaic Pattern

**Note 2** : Current fuse is built in a module. Current capacity of power supply for VDD should be larger than 1.5A, so that the fuse can be opened at the trouble of electrical circuit of module.

**Note 3** : Measure Condition

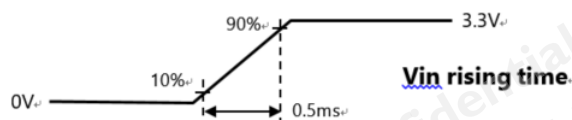
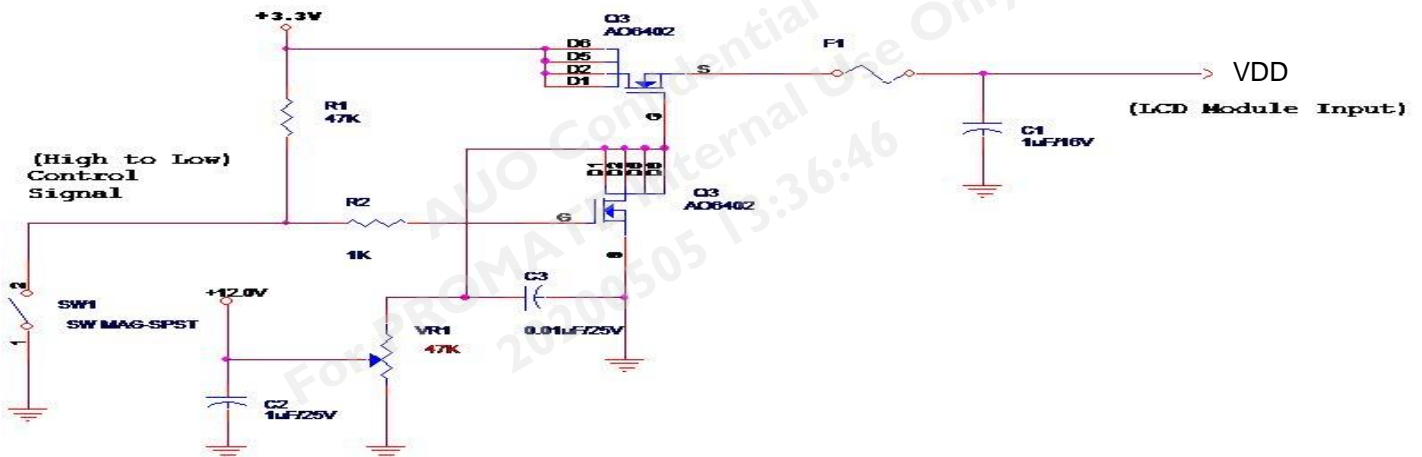

## 5.1.2 LVDS DC Signal Electrical Characteristics

Input signals shall be low or High-impedance state when VDD is off.

Symbol	Item	Min.	Typ.	Max.	Unit	Remark
VTH	Differential Input High Threshold			+100	[mV]	VCM=1.2V
VTL	Differential Input Low Threshold	-100			[mV]	VCM=1.2V
VID	Input Differential Voltage	100		600	[mV]	
VICM	Differential Input Common Mode Voltage	1.0	1.2	1.5	[V]	VTH/VTL=+-100mV

**Note:** LVDS Signal Waveform.

$V_P - V_N = |VID| > V_{TH} = \text{“High”}$   
 $V_P - V_N = -|VID| < V_{TL} = \text{“Low”}$

### Single-end Signal

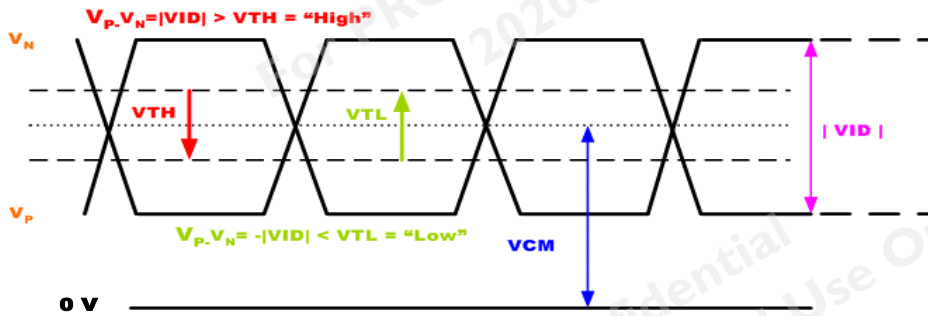

### Differential Signal

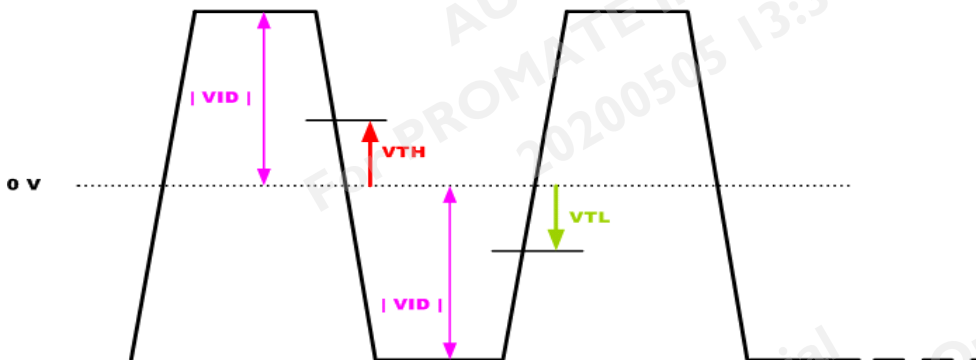

## 5.2 Backlight Unit

### 5.2.1 LED Backlight Unit : Driver Connector

Connector Name / Designation	Lamp Connector
Manufacturer	Entery
Connector Model Number	3808K-F05N-02 or compatible
Mating Model Number	H208K-D05N-22B or compatible

Pin No.	Symbol	Description
Pin1	VLED	12V input
Pin2	GND	GND
Pin3	VLED_EN	5V-ON,0V-OFF
Pin4	VPWM_EN	PWM
Pin5	NA	NC

### 5.2.3 Parameter guideline for LED

Following characteristics are measured under a stable condition using an inverter at 25°C (Room temperature)

#### LED characteristics

Parameter	Symbol	Min	Typ	Max	Units	Condition
Backlight Power Consumption	PLED	-	8.3	10.4	[Watt]	(Ta=25°C), Note 1 Vin =12V
LED Life-Time	N/A	50,000	-	-	Hour	(Ta=25°C), Note 2,3

**Note 1:** Ta means ambient temperature of TFT-LCD module.

**Note 2:** If G156HAN02.3 module is driven at high ambient temperature & humidity condition. The operating life will be reduced.

**Note 3:** Operating life means brightness goes down to 50% initial brightness. Min. operating life time is estimated data.



# Product Specification

G156HAN02.3

AU OPTRONICS CORPORATION

AUO Confidential  
For PROMATE Internal Use Only  
20200505 13:36:46

AUO Confidential  
For PROMATE Internal Use Only  
20200505 13:36:46

AUO Confidential  
For PROMATE Internal Use Only  
20200505 13:36:46

AUO Confidential  
For PROMATE Internal Use Only  
20200505 13:36:46



## Backlight input signal characteristics

Parameter	Symbol	Min	Typ	Max	Units	Remark
LED Power Supply	VLED	10.8	12	13.2	[Volt]	Define as Connector Interface (Ta=25°C)
LED Enable Input High Level	VLED_EN	2.5	--	5.5	[Volt]	
LED Enable Input Low Level		0	--	0.7	[Volt]	
PWM Logic Input High Level	VPWM_EN	2.5	--	5.5	[Volt]	
PWM Logic Input Low Level		0	--	0.7	[Volt]	
PWM Input Frequency	FPWM	200	1K	15K	Hz	
PWM Duty Ratio	Duty	10	--	100	%	

**Note 1** : Recommended system pull up/down resistor no bigger than 10kohm.

## 6. Signal Interface Characteristic

### 6.1 Pixel Format Image

Following figure shows the relationship of the input signals and LCD pixel format.

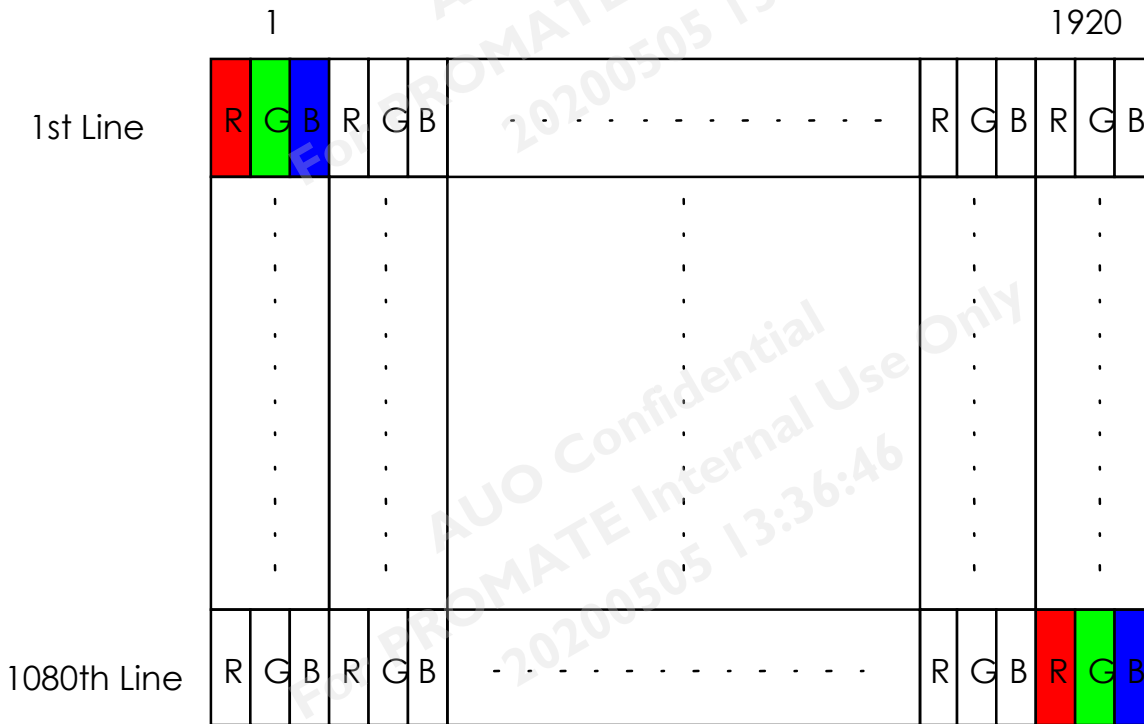



## 6. 2 Signal Description

The module uses a LVDS receiver embedded in AUO's ASIC. LVDS is a differential signal technology for LCD interface and a high-speed data transfer device.

### 6.2.1 TFT LCD Module: LVDS Connector

<b>TFT-LCD Connector</b>	Manufacturer	P-TWO	STM
	Part Number	187034-3009	MSBKT2407P30HB
<b>Mating Connector</b>	Manufacturer	JAE or Equivalent	
	Part Number	FI-X30HL (Locked Type)	

PIN #	Symbol	Description	Remark
1	RxO0-	Negative LVDS differential data input (Odd data)	
2	RxO0+	Positive LVDS differential data input (Odd data)	
3	RxO1-	Negative LVDS differential data input (Odd data)	
4	RxO1+	Positive LVDS differential data input (Odd data)	
5	RxO2-	Negative LVDS differential data input (Odd data)	
6	RxO2+	Positive LVDS differential data input (Odd data)	
7	GND	Ground	
8	RxOCLK-	Negative LVDS differential clock input (Odd clock)	
9	RxOCLK+	Positive LVDS differential clock input (Odd clock)	
10	RxO3-	Negative LVDS differential data input (Odd data)	
11	RxO3+	Positive LVDS differential data input (Odd data)	
12	RxE0-	Negative LVDS differential data input (Even data)	
13	RxE0+	Positive LVDS differential data input (Even data)	
14	GND	Ground	
15	RxE1-	Negative LVDS differential data input (Even data)	
16	RxE1+	Positive LVDS differential data input (Even data)	
17	GND	Ground	
18	RxE2-	Negative LVDS differential data input (Even data)	
19	RxE2+	Positive LVDS differential data input (Even data)	
20	RxECLK-	Negative LVDS differential clock input (Even clock)	
21	RxECLK+	Positive LVDS differential clock input (Even clock)	
22	RxE3-	Negative LVDS differential data input (Even data)	
23	RxE3+	Positive LVDS differential data input (Even data)	
24	GND	Must Connect to GND	
25	NC	No connection (for AUO test only. Do not connect)	
26	NC	No connection (for AUO test only. Do not connect)	
27	NC	No connection (for AUO test only. Do not connect)	

28	VDD	Power Supply Input Voltage	
29	VDD	Power Supply Input Voltage	
30	VDD	Power Supply Input Voltage	

**Note 1:** Input signals shall be low or High-impedance state when VDD is off.

## 6.2.2 Connector Illustration

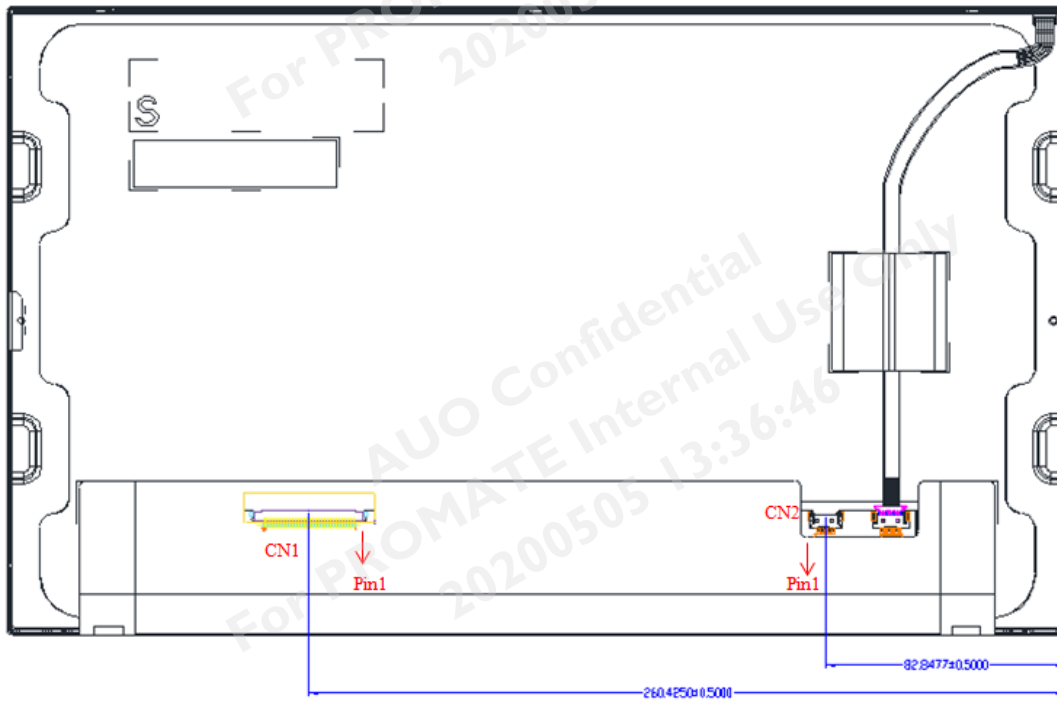

**LVDS (CN1):**

**BLU Power in (CN2):**

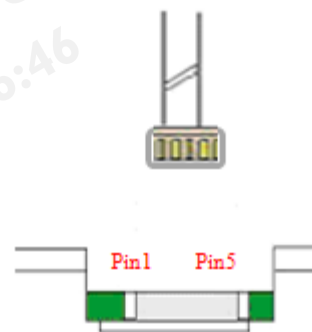
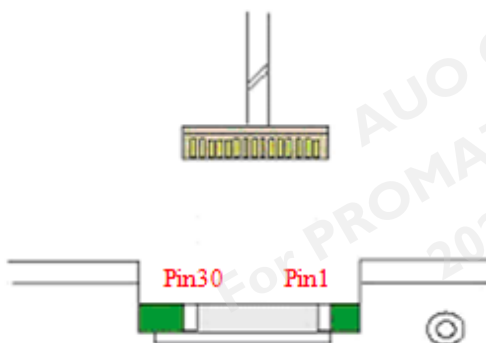

## 6.3 The Input Data Format

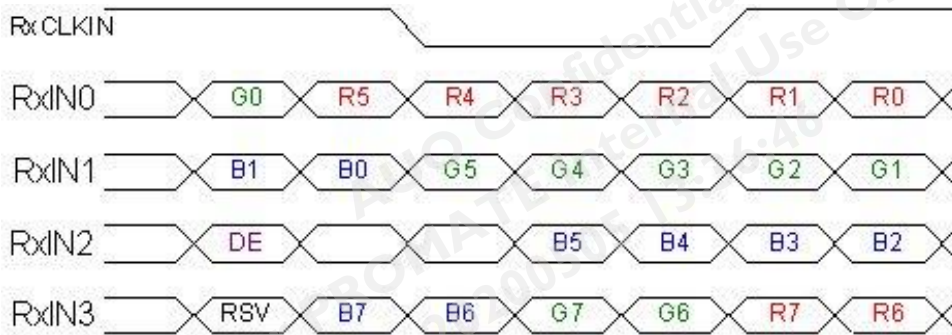

**Note1:** Please follow PSWG.

**Note2:** R/G/B data 7:MSB, R/G/B data 0:LSB

Signal Name	Description	Remark
R7 R6 R5 R4 R3 R2 R1 R0	Red Data 7 Red Data 6 Red Data 5 Red Data 4 Red Data 3 Red Data 2 Red Data 1 Red Data 0	Red-pixel Data 8Bits LVDS input MSB: R7 ; LSB: R0
G7 G6 G5 G4 G3 G2 G1 G0	Green Data 7 Green Data 6 Green Data 5 Green Data 4 Green Data 3 Green Data 2 Green Data 1 Green Data 0	Green-pixel Data 8Bits LVDS input MSB: G7 ; LSB: G0
B7 B6 B5 B4 B3 B2 B1 B0	Blue Data 7 Blue Data 6 Blue Data 5 Blue Data 4 Blue Data 3 Blue Data 2 Blue Data 1 Blue Data 0	Blue-pixel Data 8Bits LVDS input MSB: B7 ; LSB: B0
RxCLKIN	LVDS Data Clock	
DE	Data Enable Signal	When the signal is high, the pixel data shall be valid to be displayed.

**Note:** Output signals from any system shall be low state or High-impedance state when VDD is off.

## 6.4 Interface Timing

### 6.4.1 Timing Characteristics

Basically, interface timings should match the 1920x1080 /60Hz manufacturing guide line timing.

Parameter	Symbol	Min.	Typ.	Max.	Unit	
Frame Rate	-	-	60	-	Hz	
Clock frequency	$1/T_{Clock}$	68.5	70.5	73	MHz	
Vertical Section	Period	$T_V$	1104	1116	1080+A	$T_{Line}$
	Active	$T_{VD}$	1080			
	Blanking	$T_{VB}$	24	36	A	
Horizontal Section	Period	$T_H$	1050	1052	960+B	$T_{Clock}$
	Active	$T_{HD}$	960			
	Blanking	$T_{HB}$	90	92	B	

**Note1** : The above is as optimized setting

**Note2** : The maximum clock frequency =  $[(960 + B) * (1080 + A) * 60] < 74.5\text{MHz}$

**Note3** : Horizontal related parameters must be constant without variation ( H\_Sync\_Width( $T_{HW}$ ), H\_Front\_Porch( $T_{HF}$ ) and H\_Back\_Porch( $T_{HP}$ ) must be constant on each scan line).

**Note4** : On vertical blank area, H\_Sync\_Width ( $T_{HW}$ )and H\_Total( $T_H$ ) must be same as on the V\_Active area.

**Note5** : Vertical related parameters must be constant without variation.( V\_Sync\_Width( $T_{VW}$ ), V\_Front\_Porch( $T_{VF}$ ) and V\_Back\_Porch( $T_{VP}$ ) must be constant on each video field ).

**Note6** : The DE timings also must be constant without variation( H/V timing requirements are as same as previous. Blank timing must also be constant ).

### 6.4.2 Input Timing Diagram

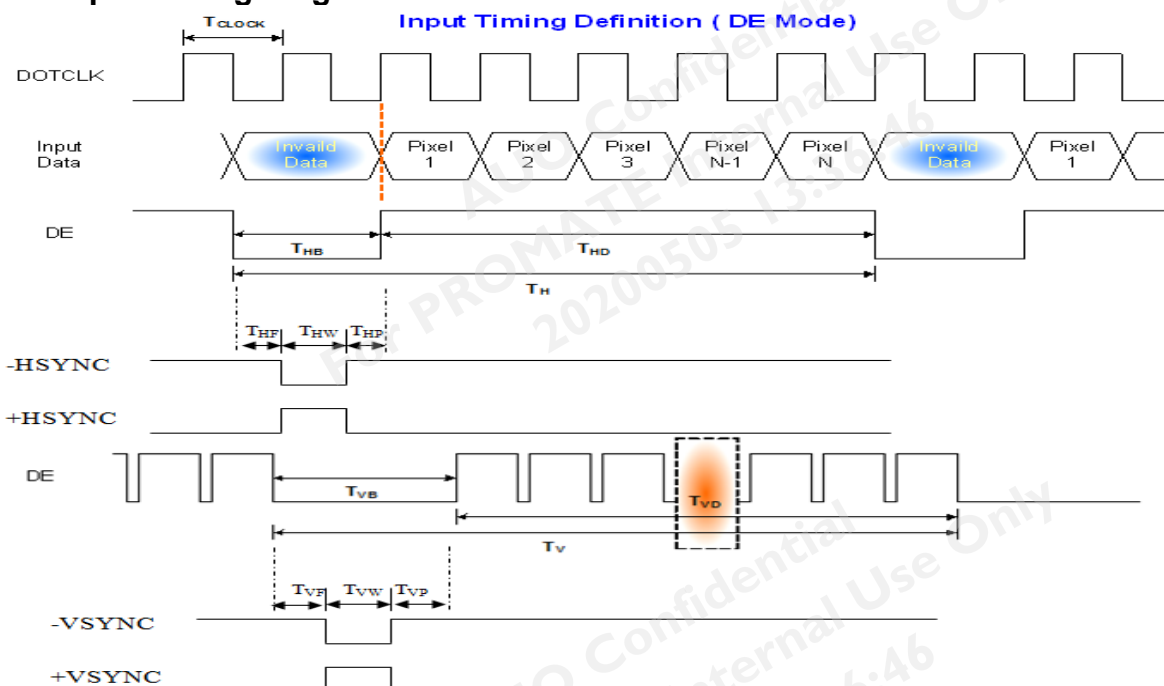

## 6.5 Power ON/OFF Sequence

VDD power and lamp on/off sequence is as below. Interface signals are also shown in the chart. Signals from any system shall be High-impedance state or low level when VDD is off.

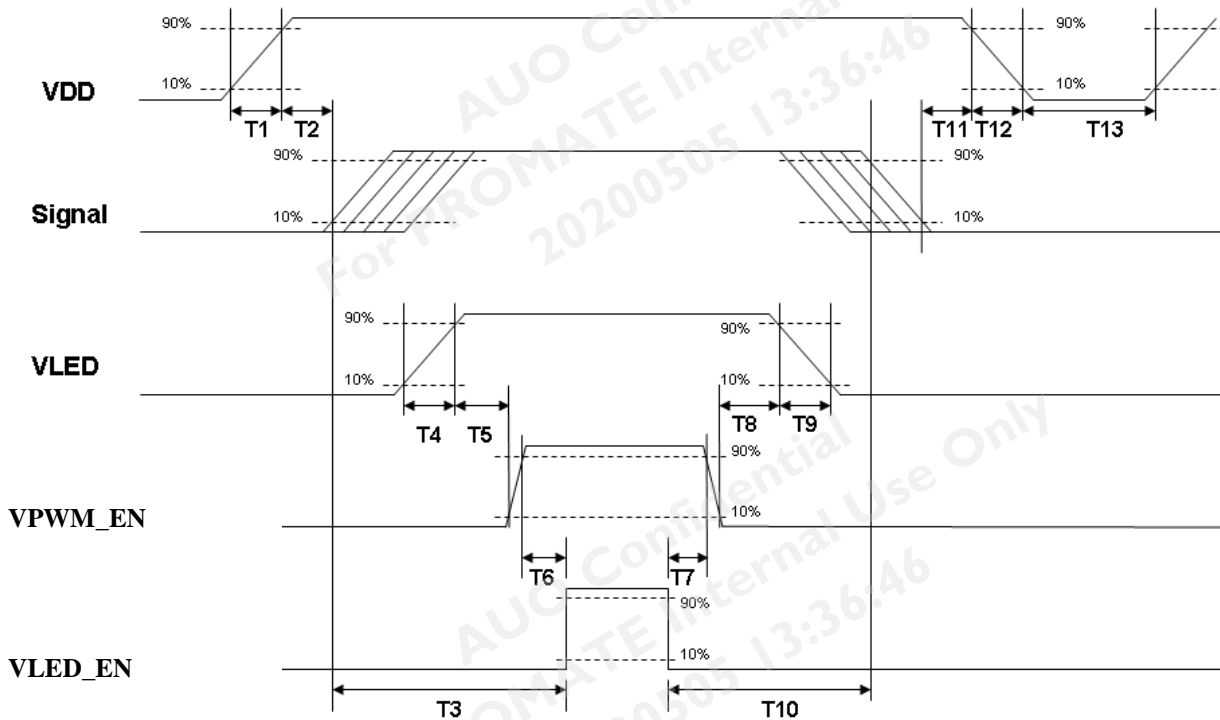

### Power ON/OFF sequence timing

Parameter	Value			Units
	Min.	Typ.	Max.	
T1	0.5	--	10	[ms]
T2	30	40	50	[ms]
T3	200	--	--	[ms]
T4	0.5	--	10	[ms]
T5	10	--	--	[ms]
T6	10	--	--	[ms]
T7	0	--	--	[ms]
T8	10	--	--	[ms]
T9	--	--	10	[ms]
T10	110	--	--	[ms]
T11	0	16	50	[ms]
T12	--	--	10	[ms]
T13	1000	--	--	[ms]

The above on/off sequence should be applied to avoid abnormal function in the display. Please make sure to turn off the power when you plug the cable into the input connector or pull the cable out of the connector.

## 7. Panel Reliability Test

Items	Required Condition	Note
<b>Temperature Humidity Bias</b>	Ta= 50°C, 80%RH, 300h	Note 2
<b>High Temperature Operation</b>	Ta= 70°C, Dry, 300h (For panel surface temp.)	
<b>Low Temperature Operation</b>	Ta= -20°C, 300h	
<b>High Temperature Storage</b>	Ta= 70°C, 300h	
<b>Low Temperature Storage</b>	Ta= -20°C, 300h	
<b>Thermal Shock Test</b>	Ta= -20°C to 60°C, Duration at 30 min, 100 cycles	
<b>Vibration</b>	Test method: Non-Operation Acceleration: 1.5 G Frequency: 10 - 200 -10Hz Sweep: Sine wave vibration; 30 minutes each axis (X, Y, Z)	
<b>Mechanical Shock</b>	Test method: Non-Operation Acceleration: 50 G; Wave: Half-sine Active time: 20 ms Direction: ±X,±Y,±Z (one time for each axis)	
<b>Drop Test</b>	Height: 46 cm, package test	
<b>ESD</b>	Contact : ±8 KV Air : ±15 KV	Note 1

**Note 1:** According to EN 61000-4-2 , ESD class B: Some performance degradation allowed. Self-recoverable. No data lost, No hardware failures.

**Note 2:**

- Water condensation is not allowed for each test items.
- Each test is done by new TFT-LCD module. Don't use the same TFT-LCD module repeatedly for reliability test.
- The reliability test is performed only to examine the TFT-LCD module capability.
- To inspect TFT-LCD module after reliability test, please store it at room temperature and room humidity for 24 hours at least in advance.
- No function failure occurs. Mura shall be ignored after high temperature reliability test



## 8. Mechanical Characteristics

### 8.1 LCM Outline Dimension (Front View)

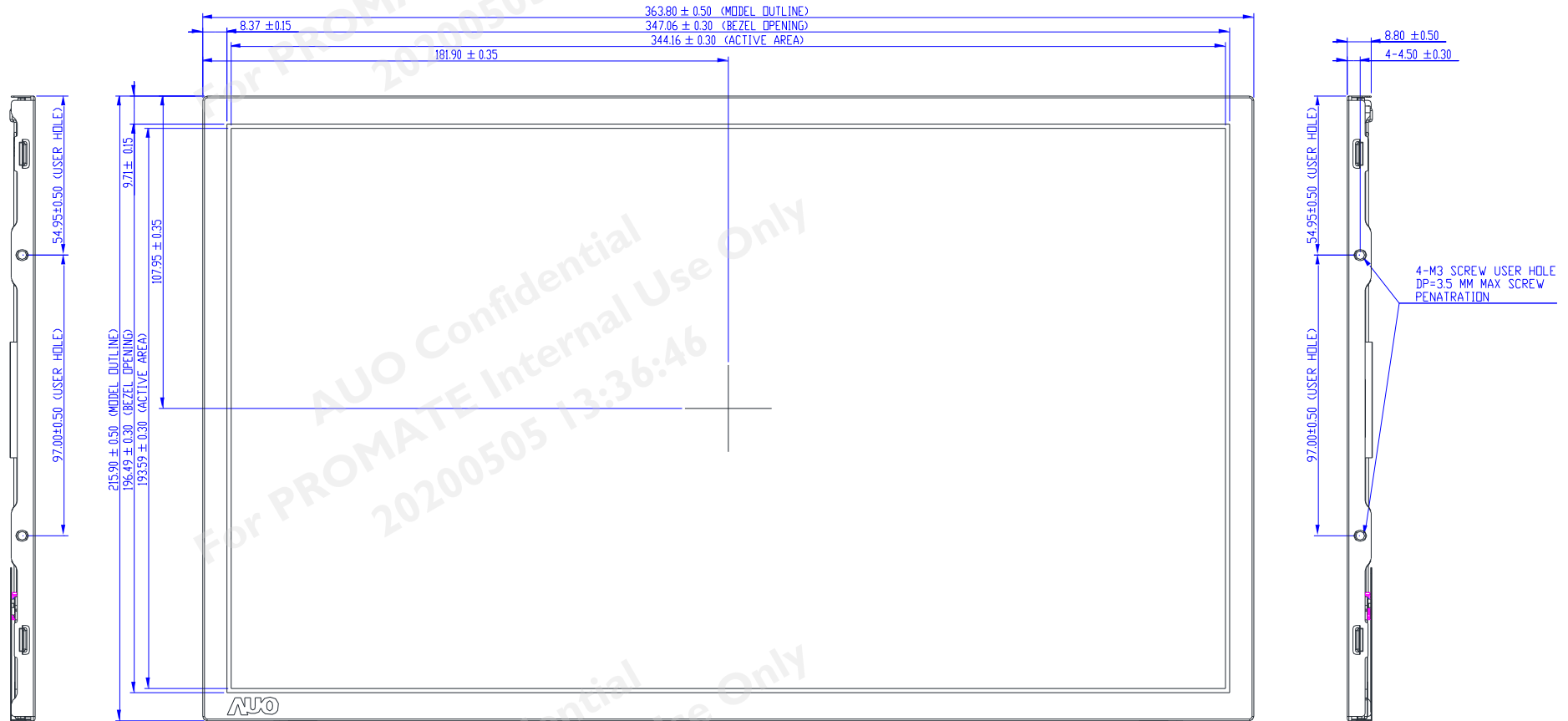

**Note:**

1. Tolerance without specified to be +/-0.5mm.
2. Torque of M3 user hole should be within 4Kg-cm and re-screw 10times.



8.2 LCM Outline Dimension (Rear View)

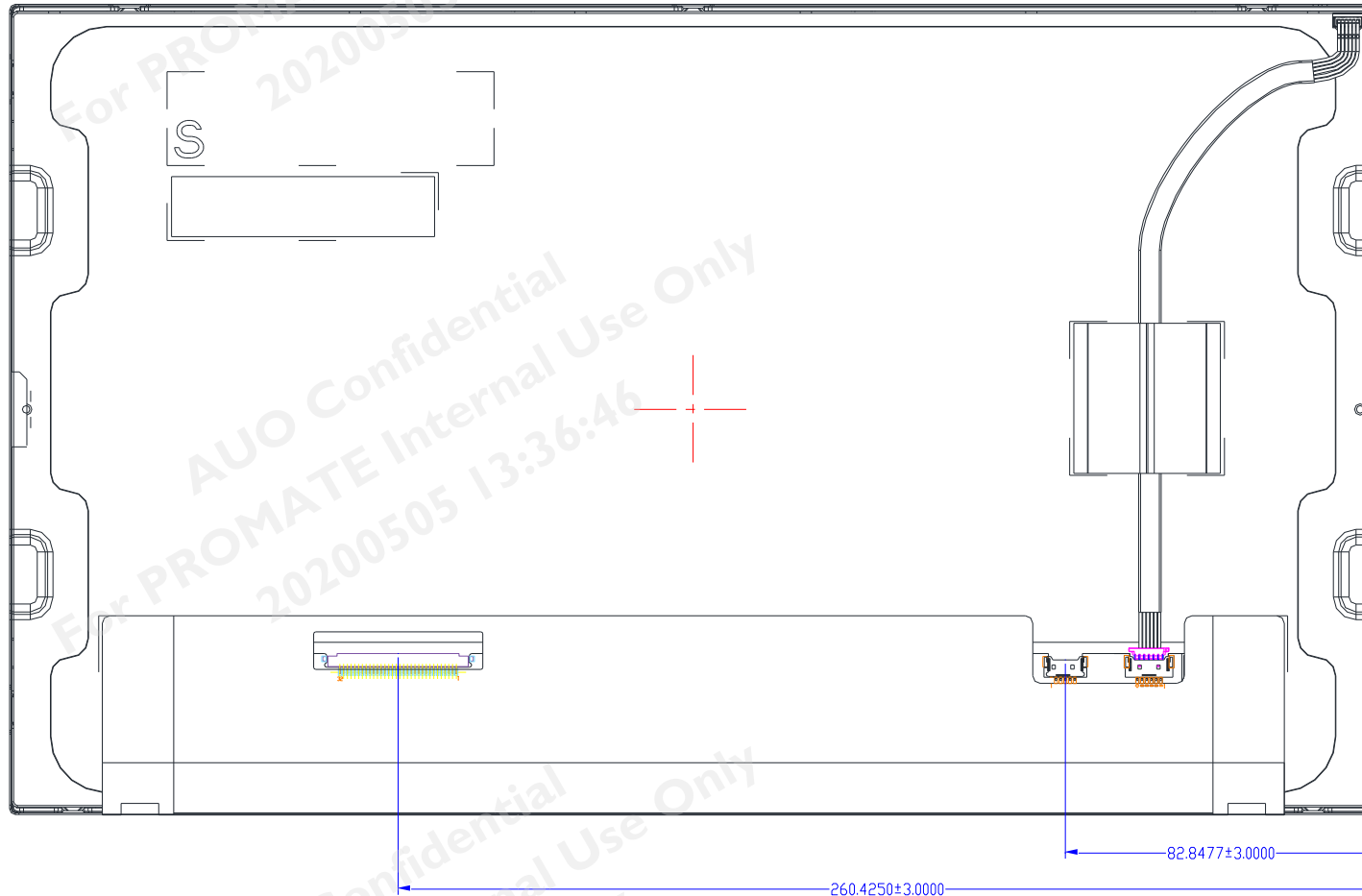





9. Label and Packaging

9.1 Shipping Label (on the rear side of TFT-LCD display)

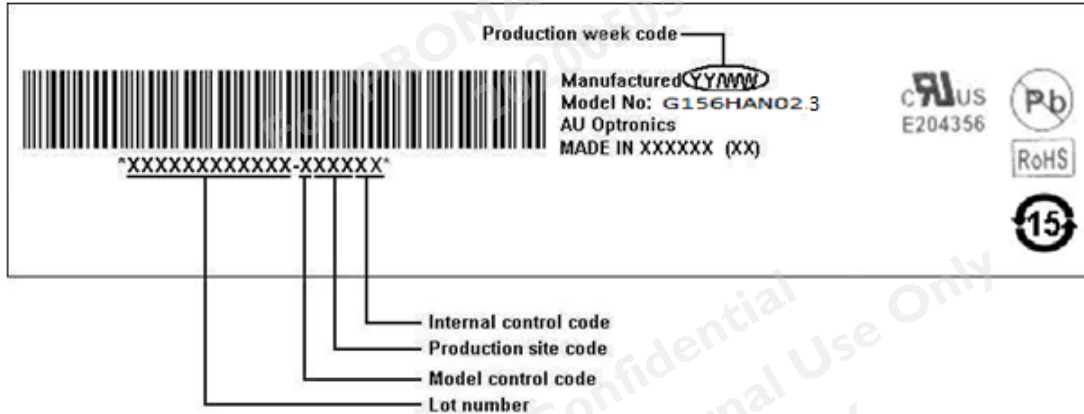

**Note 1:** For Pb Free products, AUO will add  for identification.

**Note 2:** For RoHS compatible products, AUO will add  for identification.

**Note 3:** For China RoHS compatible products, AUO will add  for identification.

**Note 4:** The Green Mark will be presented only when the green documents have been ready by AUO Internal Green Team.



## 9.2 Carton Package

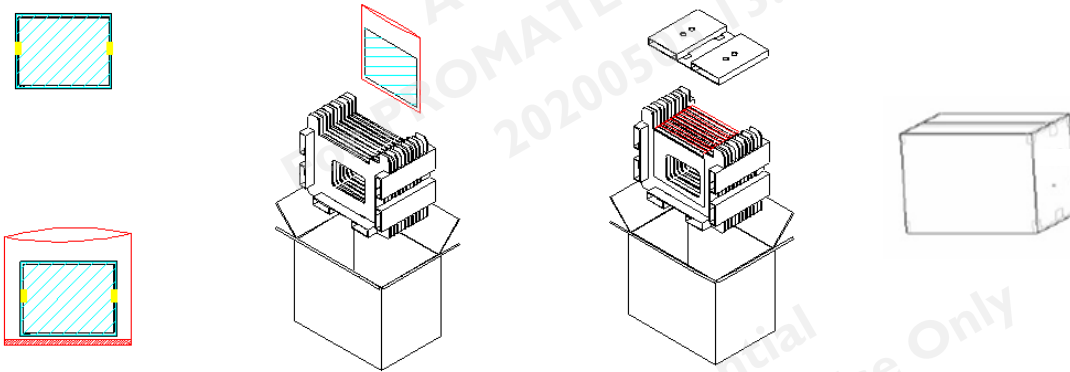

Max capacity : 16 TFT-LCD module per carton

Max weight: 13.2 Kg per carton

Outside dimension of carton: 450mm(L)\*375mm(W)\*319mm(H)

Pallet size : 1150 mm \* 910 mm \* 132mm

### Box stacked

Module by air : (2 \*3) \*4 layers , one pallet put 24 boxes , total 384pcs module

Module by sea : (2 \*3) \*4 layers+(2 \*3) \*1 layers , two pallet put 30 boxes , total 480pcs module

Module by sea\_HQ : (2 \*3) \*4 layers+(2 \*3) \*2 layers , two pallet put 42 boxes , total 576 pcs module

## 9.3 Shipping Package of Palletizing Sequence

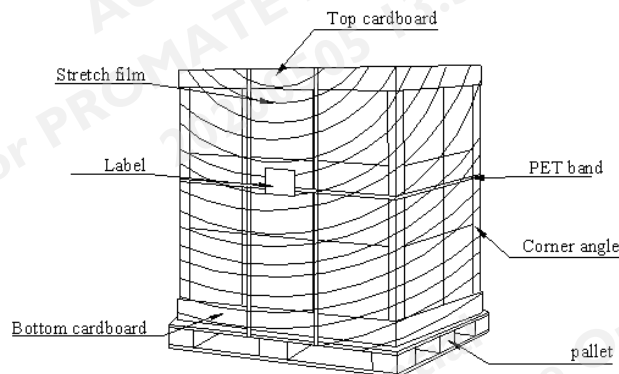



## 10. Safety

### 10.1 Sharp Edge Requirements

There will be no sharp edges or corners on the display assembly that could cause injury.

### 10.2 Materials

#### 10.2.1 Toxicity

There will be no carcinogenic materials used anywhere in the display module. If toxic materials are used, they will be reviewed and approved by the responsible AUO toxicologist.

#### 10.2.2 Flammability

All components including electrical components that do not meet the flammability grade UL94-V1 in the module will complete the flammability rating exception approval process.

The printed circuit board will be made from material rated 94-V1 or better. The actual UL flammability rating will be printed on the printed circuit board.

### 10.3 Capacitors

If any polarized capacitors are used in the display assembly, provisions will be made to keep them from being inserted backwards.

### 10.4 National Test Lab Requirement

The display module will satisfy all requirements for compliance to:

UL 60950-1 second edition U.S.A. Information Technology Equipment



**11. Handling guide**

This is a LCD model, and please be cautious when pulling it out of package or assembling it onto platform. Careless handlings, e.g. twist, bending, pressing, or collision, will result malfunction of LCD models.

**(1) Handling method notice**



Do not lift and hold the panel with Single hand at right or left side from tray.



Lift and hold the panel up with both hands from tray.

**(2) On the table notice**



Do not press edge of panel to avoid glass broken.



Do not press the surface of the panel to avoid the glass broken or polarizer scratch.



Do not put anything or tool on the panel to avoid the glass broken or polarizer scratch.

### (3) Cable assembly notice

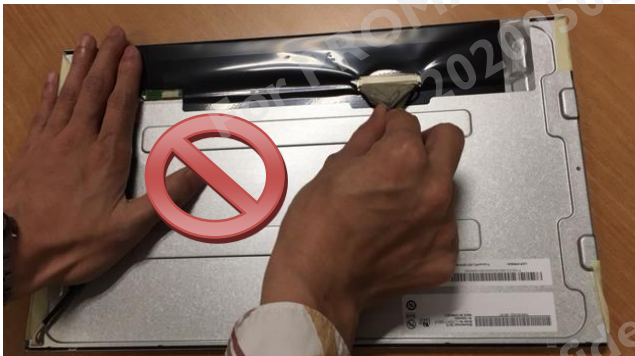

Do not insert the connector with single hand and touching the PCBA.



Insert the connector by pushing right and left edge.